



Fábregas

Parques y Jardines Fábregas S.A.U.

CATÁLOGO GENERAL

www.grupfabregas.com

Fábregegas



Fábregegas

ÍNDICE



Bancos
Papeleras
Jardineras
Fuentes
Alcorques
Pilonas
Varios
Biosaludables

Tarifa de precios

INDEX











Benches
Rubbish bins
Planters
Fontains
Tree grills
Bollards
Varius
Outdoor Gyms

Pricing list

INDEX



Bancs	04	
Corbeilles	30	
Jardinieres	42	
Fontaines	47	
Entourages	53	
Potelets	58	
Divers	65	
Fitness	72	

Liste de prix 77

Fábregas



BANCOS

BENCHES / BANCS



BANCOS / BENCHES / BANCS

MOD010 ALUMINIO



▲ Mod. MODO10-1800-AL-AZU

- ✓ **PIE DE ALUMINIO ANODIZADO AG3**
- ✓ **LISTÓN DE ALUMINIO**

- ✓ **Anodized aluminium AG3 leg**
- ✓ **Aluminium slats**

- ✓ **Pied en aluminium anodisé AG3**
- ✓ **Lames de aluminium**

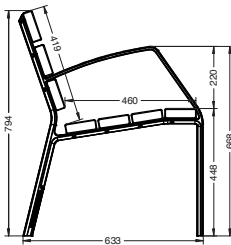

MOD010

Mod. MODO10-0700-AL-AZU
Mod. MODO10-1800-AL-AZU
Mod. MODO10-3000-AL-AZU

Pies de aluminio anodizado AG3
7 tablones aluminio

Anodized aluminium AG3 legs
7 aluminium slats

Pieds en aluminium anodisé AG3
7 lames de aluminium



▲ Mod. MODO10-0700-AL-AZU



▲ Mod. MODO10-3000-AL-AZU



BANCOS / BENCHES / BANCS

MODO10 ALUMINIO



▲ Mod. MODO10-1800-AL

- ✓ **PIE DE ALUMINIO ANODIZADO AG3**
- ✓ **LISTÓN DE ALUMINIO**

- ✓ **Anodized aluminium AG3 leg**
- ✓ **Aluminium slats**

- ✓ **Pied en aluminium anodisé AG3**
- ✓ **Lames de aluminium**

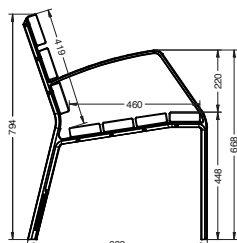

MODO10

Mod. MODO10-0700-AL
Mod. MODO10-1800-AL
Mod. MODO10-3000-AL

Pies de aluminio anodizado AG3
7 tablones aluminio

Anodized aluminium AG3 legs
7 aluminium slats

Pieds en aluminium anodisé AG3
7 lames de aluminium

▲ Mod. MODO10-0700-AL



▲ Mod. MODO10-3000-AL



BANCOS / BENCHES / BANCS

MODO10 ALUMINIO



▲ Mod. MODO10-1800

- ✓ **PIE DE ALUMINIO ANODIZADO AG3**
- ✓ **LISTÓN MADERA TROPICAL**

- ✓ **Anodized aluminium AG3 leg**
- ✓ **Tropical wood slats**

- ✓ **Pied en aluminium anodisé AG3**
- ✓ **Lames de bois tropical**

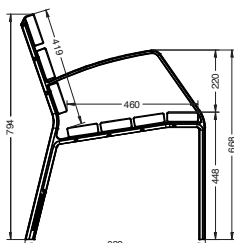

MODO10

Mod. MODO10-0700
Mod. MODO10-1800
Mod. MODO10-3000

Pies de aluminio anodizado AG3
7 tablonces madera

Anodized aluminium AG3 legs
7 wood slats

Pieds en aluminium anodisé AG3
7 lames de bois

▲ Mod. MODO10-0700



▲ Mod. MODO10-3000



MODO10
MADERA TROPICAL
Mod. MODO10-KIT

BANCOS / BENCHES / BANCS
MODO10 ALUMINIO



▲ Mod. MODO10-1800-PC

MODO10

- Mod. MODO10-0700-PC
- Mod. MODO10-1800-PC
- Mod. MODO10-3000-PC

Pies de aluminio anodizado AG3
7 tablones madera

Anodized aluminium AG3 legs
7 wood slats

Pieds en aluminium anodisé AG3
7 lames de bois



La marca de la gestión forestal responsable

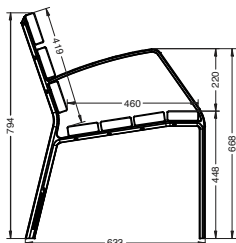

▲ Mod. MODO10-0700-PC

BANCOS / BENCHES / BANCS

MOD008 FUNDICIÓN



▲ Mod. MODO08-1800



MOD008

Mod. MODO08-0700
Mod. MODO08-1800
Mod. MODO08-3000

Pies de fundición dúctil pintados en gris martelé
6 tablones madera (1800x110x35)

Ductile cast iron legs painted in grey hammer
6 wood slats (1800x110x35)

Pieds en fonte peint en noir martelé
6 lames de bois (1800x110x35)



El único banco con certificado de producto
The only bench with product certificate
La seule banque avec certificat de produit

- ✓ **PIE DE FUNDICIÓN DÚCTIL**
- ✓ **LISTÓN MADERA TROPICAL**

- ✓ **Ductil cast leg**
- ✓ **Tropical wood slats**

- ✓ **Pied en fonte ductile**
- Lames de bois tropical**



▲ Mod. MODO08-0700

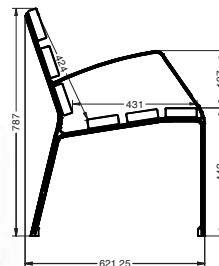

La marca de la gestión forestal responsable



MOD008
MADERA TROPICAL
Mod. MODO08-KIT

MOD008
MADERA PINO
Mod. MODO08-05-PC-KIT



▲ Mod. MODO08-3000

BANCOS / BENCHES / BANCS

MOD008 FUNDICIÓN



El único banco con certificado de producto
The only bench with product certificate
 La seule banque avec certificat de produit



▲ Mod. MODO08-1800-PC

MOD008

Mod. MODO08-0700-PC
Mod. MODO08-1800-PC
Mod. MODO08-3000-PC

Pies de fundición dúctil pintados en gris martelé
 6 tablones madera (1800x110x35)

Ductile cast iron legs painted in grey hammer
 6 wood slats (1800x110x35)

Pieds en fonte peint en noir martelé
 6 lames de bois (1800x110x35)

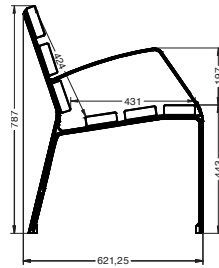

▲ Mod. MODO08-0700-PC



La marca de la gestión forestal responsable



▲ Mod. MODO08-1800-5-PC

BANCOS / BENCHES / BANCS

MOD008 FUNDICIÓN

- ✓ **PIE DE FUNDICIÓN DÚCTIL**
- ✓ **LISTÓN MADERA TÉCNICA**

- ✓ **Ductil cast leg**
- ✓ **Technical wood slats**

- ✓ **Pied en fonte ductile**
- ✓ **Lames de bois technique**

Producto certificado



▲ Mod. MODO08-1800-MT

MOD008-1800-MT

Pies de fundición dúctil pintados en gris martelé
6 tablones madera técnica
(1800x110x35)

Ductile cast iron legs painted in grey hammer
6 technical wood slats
(1800x110x35)

Pieds en fonte peint en noir martelé
6 lames de bois technique
(1800x110x35)

MOD008-1800-PR

Pies de fundición dúctil pintados en gris martelé
6 listones polímero reciclado
(1800x110x35)

Ductile cast iron legs painted in grey hammer
6 recycled polymer wood slats
(1800x110x35)

Pieds en fonte peint en noir martelé
6 lames de bois polymère recyclé
(1800x110x35)



▲ Mod. MODO08-1800-PR

- ✓ **PIE DE FUNDICIÓN DÚCTIL**
- ✓ **LISTÓN POLÍMERO RECICLADO**

- ✓ **Ductil cast leg**
- ✓ **Recycled polymer wood slats**

- ✓ **Pied en fonte ductile**
- ✓ **Lames de bois polymère recyclé**



BANCOS / BENCHES / BANCS

GAMA SIMILAR

SIMILAR MADERA



◀ Mod. C-1016

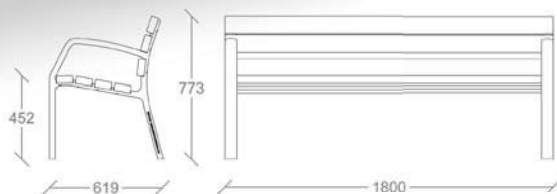

Mod. C-1016
Mod. C-1016-SILLA
Mod. C-1016-3M

Pies en fundición dúctil, acabados con pintura oxirón al horno
 Madera de guinea tratada y barnizada con lasur a poro abierto
 Opcional en madera certificada

Ductile cast iron legs, powder coated with Oxiron paint. Guinea Wood treated and lasur varnished with open pore
 Optional in certified wood

Pieds en fonte ductile avec couche de fond et finition peint noir oxyron
 Le bois traité Guinée lasure vernis à pores ouverts.
 En option certifié

Mod. C-1015 ▶

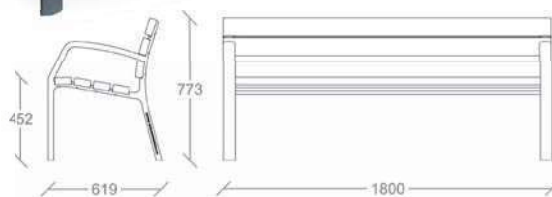
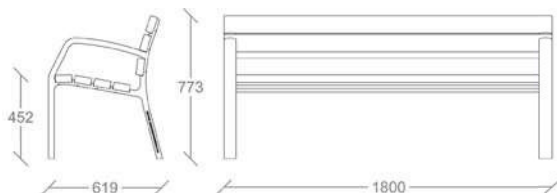

La marca de la gestión forestal responsable

◀ Mod. C-1016-PC

Pies en fundición dúctil, acabados con pintura oxirón al horno.
 Madera de pino autoclave clase IV, certificada

Ductile cast iron legs, Coated with Oxiron paint
 Pine wood autoclave class IV, certified

Pieds en fonte ductile avec couche de fond et finition peint noir oxyron
 Pin bois certifié autoclave, classe IV

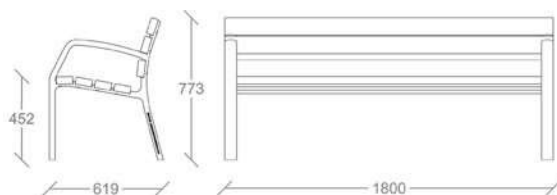

La marca de la gestión forestal responsable



◀ Mod. C-1015-PC



MAVERICK

Mod. C-1018

Chapa troquelada, galvanizada y pintada
Pies de fundición dúctil pintados en gris martelé

Perforated sheet galvanized and painted
Ductile cast iron legs painted in grey hammer

Tôle perforée galvanisé et peint
Pieds en fonte peint en noir martele

ABSTRACT

Mod. C-1019

Chapa troquelada, galvanizada y pintada
Pies de fundición dúctil pintados en gris martelé

Perforated sheet galvanized and painted
Ductile cast iron legs painted in grey hammer

Tôle perforée galvanisé et peint
Pieds en fonte peint en noir martele

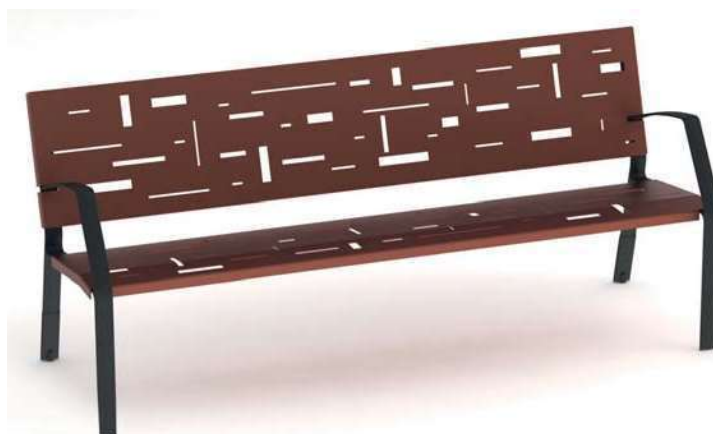

**SIMILAR FUNDICIÓN
LA FOREST**

Mod. C-1011

Totalmente en fundición dúctil
Acabado con pintura oxiron al horno

Totally in ductile cast iron
Powder coated with Oxiron paint

Tout en fonte ductile
Couche de fond et finition peint noir oxyron

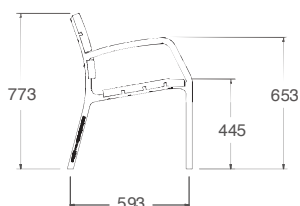
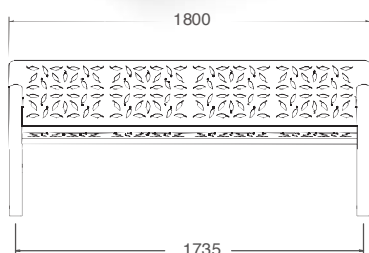

BANCOS / BENCHES / BANCS



▲ **Mod. C-1002-106-MAR**

Acero pintado martelé / steel black hammer paint / acier pient noir martele

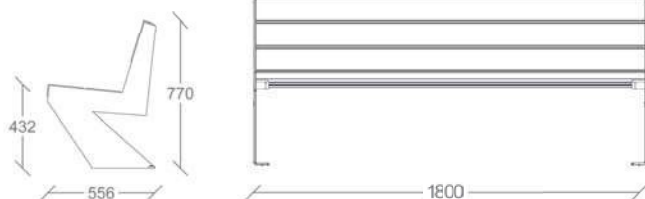

ZENIT 6

Mod. C-1002-106

Mod. C-1002-106-COR

Mod. C-1002-106-GA

Mod. C-1002-106-MAR

Madera de guinea tratada, de 35 mm de espesor y barnizada con lasur a poro abierto. 4 posibles acabados de pies: ACERO INOXIDABLE PULIDO, ACERO CORTEN, ACERO PINTADO PLATA, ACERO PINTADO MARTELÉ

Guinea Wood treated and lasur varnished with open pore. 4 possible legs finish: STAINLESS STEEL, WEATHERING STEEL, SILVER PAINTED STEEL, STEEL BLACK HAMMER PAINT

Le bois traité Guinée lasure vernis à pores ouverts. 4 finitions possibles: INOXYDABLE POLI, CORTEN VERNIS, ACIER PEINT ARGENT, ACIER PEINT NOIR MARTELE

ZENIT

Mod. C-1002

Mod. C-1002-COR

Mod. C-1002-GA

Mod. C-1002-MAR

Madera de guinea tratada, de 60 mm de espesor y barnizada con lasur a poro abierto. 4 posibles acabados de pies: ACERO INOXIDABLE PULIDO, ACERO CORTEN, ACERO PINTADO PLATA, ACERO PINTADO MARTELÉ

Guinea Wood treated and lasur varnished with open pore. 4 possible legs finish: STAINLESS STEEL, WEATHERING STEEL, SILVER PAINTED STEEL, STEEL BLACK HAMMER PAINT

Le bois traité Guinée lasure vernis à pores ouverts. 4 finitions possibles: INOXYDABLE POLI, CORTEN VERNIS, ACIER PEINT ARGENT, ACIER PEINT NOIR MARTELE



◀ **Mod. C-1002**

Inox / stainless steel / inox

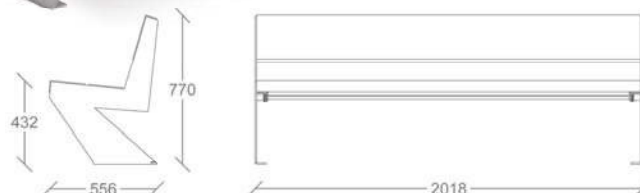

▲ **Mod. C-1002-M-MAR**

Acero pintado martelé / steel black hammer paint / acier pient noir martele

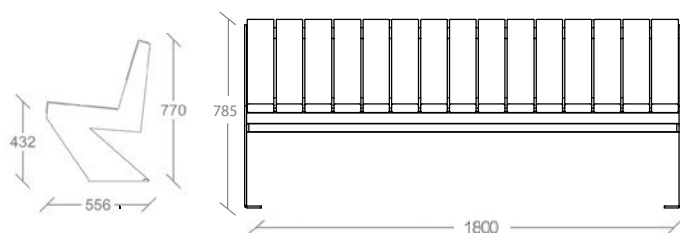

ZENIT MÍMIM

Mod. C-1002-M

Mod. C-1002-M-COR

Mod. C-1002-M-GA

Mod. C-1002-M-MAR

Madera de guinea tratada y barnizada con lasur a poro abierto. 4 posibles acabados de pies: ACERO INOXIDABLE PULIDO, ACERO CORTEN, ACERO PINTADO PLATA, ACERO PINTADO MARTELÉ

Guinea Wood treated and lasur varnished with open pore. 4 possible legs finish: STAINLESS STEEL, WEATHERING STEEL, SILVER PAINTED STEEL, STEEL BLACK HAMMER PAINT

Le bois traité Guinée lasure vernis à pores ouverts. 4 finitions possibles: INOXYDABLE POLI, CORTEN VERNIS, ACIER PEINT ARGENT, ACIER PEINT NOIR MARTELE

BANCOS / BENCHES / BANCS

GAMA MODO

MODO MADERA

Mod. C-106
Mod. C-106-SILLA
Mod. C-106-3M

Pies en fundición dúctil, acabados con pintura oxirón al horno
Madera de guinea tratada y barnizada con lasur a poro abierto.
Opcional en madera certificada

Ductile cast iron legs, Powder coated with Oxiron paint
Guinea Wood treated and lasur varnished with open pore
Optional in certified wood

Pieds en fonte ductile avec couche de fond et finition peint noir oxyron
Le bois traité Guinée lasure vernis à pores ouverts
En option bois certifié



◀ **Mod. C-106**

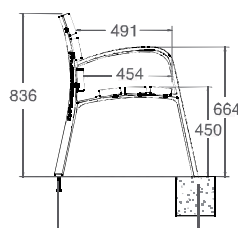
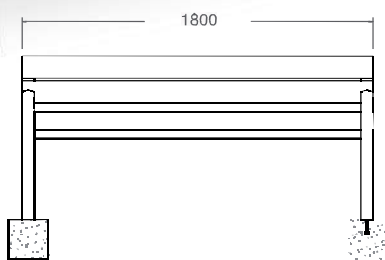

▲ **Mod. C-106-3M**

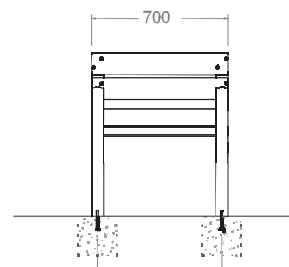
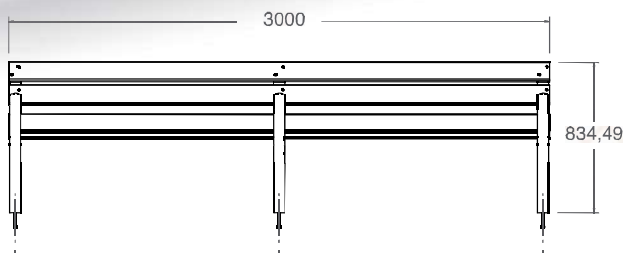

▲ **Mod. C-106-SILLA**



▲ **Mod. C-106 FU-PC**

Mod. C-106 FU-PC
Mod. C-106 FU-SILLA-PC
Mod. C-106 FU-3M-PC

Pies en fundición dúctil, acabados con pintura oxirón al horno
Madera de pino autoclave clase IV, certificada

Ductile cast iron legs, Coated with Oxiron paint
Pine wood autoclave class IV, certified

Pieds en fonte ductile avec couche de fond et finition peint noir oxyron
Pin bois certifié, traité autoclave, classe IV



La marca de la gestión forestal responsable

BANCOS / BENCHES / BANCS GAMAPOLIETILENO



Parques y Jardines Fábregas S.A.U.

- ✓ Polietileno de gran calidad
- ✓ Tratado con UV, sin mantenimiento, Antigraffiti, gran robustez
- ✓ High quality Polyethylene
- ✓ UV protection, without maintenance, anti graffiti, high resistance to impacts
- ✓ Polyéthylène haute qualité
- ✓ Coloris stables anti-UV, sans entretien, anti-graffiti, grande résistance aux chocs



MAVERIK POLIETILENO

Mod. C-1018-PLAST

Long 1700 mm



100% RECICLABLE

Bancos Urbanos
SIN MANTENIMIENTO
RESISTENTE



COBALTO
SIMILAR RAL 5004

RAL 3020

RAL 7021

RAL 1021

RAL 5005

RAL 6029

NARANJA
SIMILAR RAL 2004



BANCOS / BENCHES / BANCS



RAL 7021



VERDE ACIDO
SIMILAR RAL 1026



CORTEN
SIMILAR RAL 8017



MODO POLIETILENO

Mod. C-106-PLAST

Long 1700 mm



100% RECICLABLE



RAL 3020



RAL 5005



NARANJA
SIMILAR RAL 2004



RAL 6029



RAL 1021



COBALTO
SIMILAR RAL 5004



CORTEN
SIMILAR RAL 8017

VERDE ACIDO
SIMILAR RAL 1026



Bancos Urbanos

SIN MANTENIMIENTO
RESISTENTE

ALVIUM

Mod. C-1017

Long 1700 mm

ACCM
PRODUCTO
CERTIFICADO
Nº: CP-22-16-101-01



100% RECICLABLE

- ✓ Polietileno de gran calidad
- ✓ Tratado con UV, sin mantenimiento, Antigraffiti, gran robustez

- ✓ High quality Polyethylene
- ✓ UV protection, without maintenance, anti graffiti, high resistance to impacts

- ✓ Polyéthylène haute qualité
- ✓ Coloris stables anti-UV, sans entretien, anti-graffiti, grande résistance aux chocs



Bancos Urbanos

**SIN MANTENIMIENTO
RESISTENTE**



RAL 6029

RAL 1021

COBALTO
SIMILAR RAL 5004



MODO ECO-PLAST

Mod. C-106-ECO-PLAST

Long 1650 mm



RAL 7021



100% RECICLABLE

GAMA POLIETILENO



COBALTO
SIMILAR RAL 5004

RAL 3020

RAL 6029

RAL 5005

CORTEN
SIMILAR RAL 8017

BANCOS / BENCHES / BANCS



RONDA

Mod. C-103

Estructura metálica imprimada y pintada color plata
Madera de guinea tratada, de 70mm de espesor y
Barnizada con lasur a poro abierto

Primed and painted metal frame silver
Guinea Wood treated and lasur varnished with open pore

Cadre métallique apprêtés et peints argent
Le bois traité Guinée lasure vernis à pores ouverts

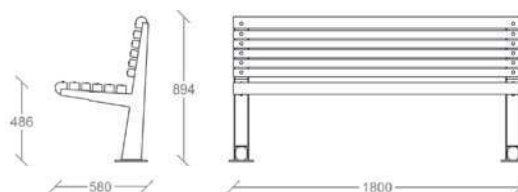

RONDA SIN

Mod. C-103 SIN

Estructura metálica imprimada y pintada color plata
Madera de guinea tratada, de 70mm de espesor y
Barnizada con lasur a poro abierto

Primed and painted metal frame silver
Guinea Wood treated and lasur varnished with open pore

Cadre métallique apprêtés et peints argent
Le bois traité Guinée lasure vernis à pores ouverts

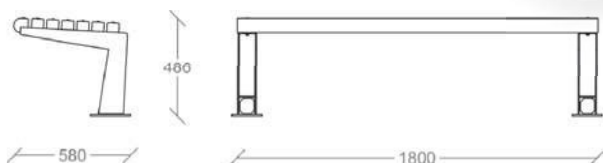

DIANA

Mod. C-109

Estructura metálica imprimada y pintada color plata
Madera de guinea tratada, de 70mm de espesor y
Barnizada con lasur a poro abierto

Primed and painted metal frame silver
Guinea Wood treated and lasur varnished with open pore

Cadre métallique apprêtés et peints argent
Le bois traité Guinée lasure vernis à pores ouverts

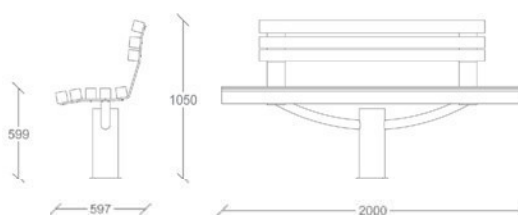

DIANA SIN

Mod. C-109 SIN

Estructura metálica imprimada y pintada color plata
Madera de guinea tratada, de 70mm de espesor y
Barnizada con lasur a poro abierto

Primed and painted metal frame silver
Guinea Wood treated and lasur varnished with open pore

Cadre métallique apprêtés et peints argent
Le bois traité Guinée lasure vernis à pores ouverts

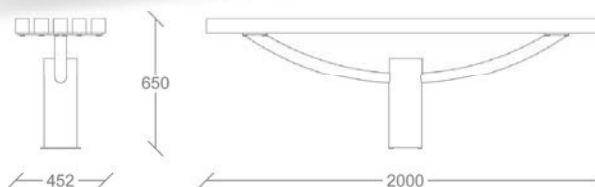



E-PICNIC

Mod. E-PICNIC-1006-OX

Pies de acero pintado
Madera tropical

Steel Legs powder coated with oxiron paint
Tropical Wood

Structure en acier peint noir
Bois tropicaux

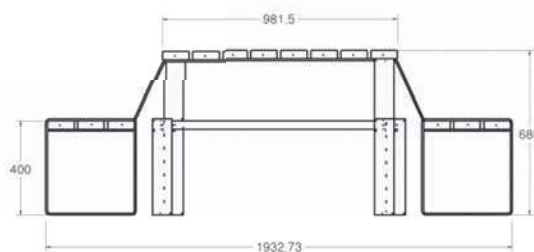

MARINA SIN

Mod. C-1006 SIN-OX Mod. C-1006 SIN-SILLA-OX

Pies de acero pintado
Madera tropical

Steel Legs powder coated with oxiron paint
Tropical Wood

Structure en acier peint noir
Bois tropicaux



◀ Mod. C-1006 SIN-OX

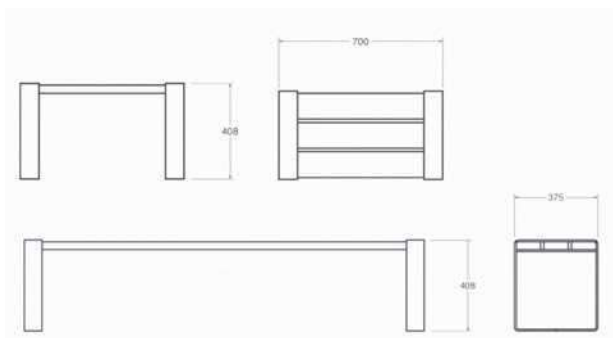

▲ Mod. C-1006 SIN-SILLA-OX

BANCOS / BENCHES / BANCS



*** Mod. C-1 MT MADERA TÉCNICA**
 60% madera reciclada - 40% polímero reciclado
 60% recycled wood - 40% recycled polymer
 60% bois recyclé - 40% polymère recyclé

ROMÁNTICO

Mod. C-1 ALTO

Pies en fundición dúctil. 18 listones de madera tropical
 Opcional: **C-1 ALTO-PC** con madera de pino certificada
C-1 ALTO-MT madera técnica*

Ductile cast iron legs. 18 strips of tropical wood
 Optional: **C-1 ALTO-PC** with certified pine wood
C-1 ALTO-MT technical wood*

Pieds en fonte ductile. 18 lattes du Bois tropical
 En option: **C-1 ALTO-PC** avec pin bois certifié
C-1 ALTO-MT bois technique*

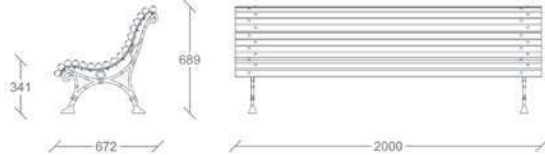

ROMÁNTICO DOBLE

Mod. C-3

Pies en fundición dúctil. 35 listones de madera tropical

Ductile cast iron legs. 35 strips of tropical wood

Pieds en fonte ductile. 35 lattes du bois tropical

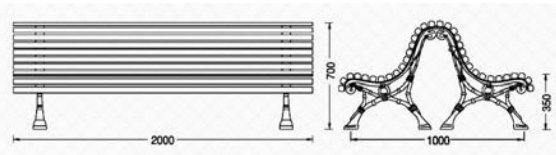

*** Mod. C-1 MT MADERA TÉCNICA**
 60% madera reciclada - 40% polímero reciclado
 60% recycled wood - 40% recycled polymer
 60% bois recyclé - 40% polymère recyclé

PLAZA REAL

Mod. C-01 ALTO

Pies en fundición dúctil. 19 listones de madera tropical
 Opcional: **C-01 ALTO-PC** con madera de pino certificada
C-01 ALTO-MT madera técnica*

Ductile cast iron legs. 19 strips of tropical wood
 Optional: **C-01 ALTO-PC** with certified pine wood
C-01 ALTO-MT technical wood*

Pieds en fonte ductile. 19 lattes du bois tropical
 En option: **C-01 ALTO-PC** avec pin bois certifié
C-01 ALTO-MT bois technique*

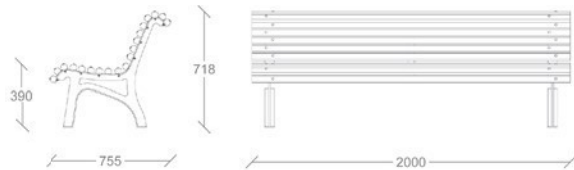

BASTIDE

Mod. C-107

Pies en fundición dúctil. Madera Tropical
 Opcional: C-107 Silla, de 0,70 cms

Ductile cast iron legs. Tropical Wood
 Optional: C-107 Silla, of 0,70 cms lenght

Pieds en fonte ductile. Bois tropical
 En option: C-107 Silla, du 0,70 cms de longueur

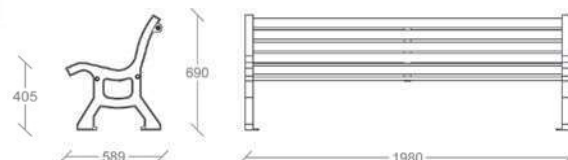



PARIS

Mod. C-113 de 2000 mm

Pies en fundición dúctil y madera tropical

Optional: C-113 PROMO de 1800mm, servido desmontado
C-113 PROMO-GC de 1800mm,
servido desmontado, com madera certificada*

Ductile cast iron legs and Tropical Wood

Optional: C-113 PROMO of 1800mm lenght, served unasssembled
C-113 PROMO-GC of 1800mm lenght,
served unasssembled, with certified wood*

Pieds en fonte ductile et bois tropical

En option: C-113 PROMO du 1800mm, livré non monté
C-113 PROMO-GC du 1800mm,
livré non monté, avec bois certifié*



PERPIGNAN

Mod. C-114 de 2000 mm

Pies en fundición dúctil y madera Tropical.

Optional: C-114 PROMO de 1800mm, servido desmontado
C-114 PROMO-GC de 1800mm, servido desmontado,
con madera certificada*

Ductile cast iron legs and Tropical Wood.

Optional: C-114 PROMO of 1800mm lenght, served unasssembled
C-114 PROMO-GC of 1800mm lenght, served
unasssembled, with certified wood*

Pieds en fonte ductile et bois tropical.

En option: C-114 PROMO du 1800mm, livré non monté
C-114 PROMO-GC du 1800mm, livré non monté, avec
bois certifié*



EUROPE

Mod. C-112

Pies en fundición dúctil y madera tropical

Ductile cast iron legs and tropical wood

Pieds en fonte ductile et bois tropical



VITORIA

Mod. C-104R-VITO-7

Pies en fundición dúctil y madera tropical de 70mm de grosor

Optional: C-104R-VITO-4 con listones de 40mm de espesor

Ductile cast iron legs with tropical wood, of 70mm thickness

Optional: C-104R-VITO-4 with 40 mm slats of thickness

Pieds en fonte ductile et bois tropical

En option: C-104R-VITO-4 avec lattes du 40mm d'épaisseur



MADRID

Mod. C-7

Pies de acero pintado y madera tropical

Optional: C-7-PC com madera de pino certificada*

Steel Legs coated with black paint and tropical wood

Optional: C-7-PC with certified pine wood*

Structure en acier peint noir et bois tropical.

En option: C-7-PC avec pin bois certifié*



La marca de la
gestión forestal
responsable

BANCOS / BENCHES / BANCS



BILBAO

Mod. C-104

Pies en fundición dúctil y madera tropical

Ductile cast iron legs and tropical wood

Pieds en fonte ductile et bois tropical



VERSALLES

Mod. C-119

Banco doble, pies en fundición y madera tropical

Opcional: C-119S simple, individual

Double seat, cast iron legs and tropical wood

Optional: C-119S simple, individual

Double banc, pieds en fonte avec bois tropical

En option: C-119S simple, individual



ALPINO

Mod. C-108-GC

Totalmente en madera de eucalipto certificada

Totally with eucalyptus wood certified

Totalment en bois d'eucalyptus certifié



La marca de la gestión forestal responsable



PILAR

Mod. C-170

Pies de acero

Madera Tropical de 40mm de grosor

Steel Legs

Tropical wood with 40mm of thickness

Structure en acier

Bois tropical, avec lattes du 40mm d'épaisseur



BANQUETTE

Mod. C-1012

Pies de acero pintado y madera tropical

Steel Legs coated with Oxiron paint and tropical wood

Structure en acier peint noir et bois tropical



MARINA MAR

Mod. C-1006-MAR-GC

Mod. C-1006-MAR-SILLA-GC

Banco con estructura de acero inoxidable AISI 316 con 8 listones de madera de Guinea certificada FSC®

Bench with structure of stainless steel AISI 316 with 8 slats of Guinea FSC® certified wood

Banc avec structure en acier inox AISI 316 8 lattes en bois Guinée certifié FSC®



La marca de la gestión forestal responsable



MARINA

Mod. C-1006

Pies de acero inoxidable y madera tropical

Stainless steel legs and tropical wood

Structure d'acier inoxydable et bois tropical



MODO ACERO

Mod. C-106 METAL

Acero y pintura poliéster al horno azul sablé 700

Steel and coated polyester paint blue sable 700

Acier avec peinture polyester bleu sablé 700



CIUTAT

Mod. C-2

Pies de acero galvanizado y pintado color plata
18 listones de madera tropical

Galvanized steel legs and silver painted
18 strips of tropical wood

Pieds en acier galvanisé et peint argent
18 lattes du bois tropical



BANCO TUBULAR

Mod. C-8-1011

Estructura tubular y chapa troquelada
Galvanizado y pintado color negro oxirón

Tubular structure and perforated sheet
Galvanized and painted black oxiron

Structure tubulaire et tôle perforée
galvanisé et peint couleur noir oxiron



FUNDICIÓN

Mod. C-111

Fundición ductil y pintado negro

Ductile cast iron with black paint

Fonte ductile et finition peint noir



CERDANYOLA

Mod. C-102

Estructura metálica galvanizada y pintada color plata

Galvanized and painted silver

Galvanisé et peint couleur argent



CHAPA PERFORADA

Mod. C-8

Estructura tubular y chapa perforada
Galvanizado y pintado color plata

Tubular structure and perforated sheet
Galvanized and silver painted

Structure tubulaire et tôle perforée
Galvanisé et peint couleur argent

ISIS

Mod. C-1010

Hormigón con armadura de acero galvanizado
Textura lisa, color blanco

Concrete with galvanized steel armor
Smooth texture, white

Béton avec armature acier galvanisé
Texture lisse, couleur blanc



ZEUS

Mod. C-1008

Hormigón con armadura de acero galvanizado
Textura lisa, color blanco

Concrete with galvanized steel armor
Smooth texture, white

Béton avec armature acier galvanisé
Texture lisse, couleur blanc



DOLMEN

Mod. C-1009

Hormigón con armadura de acero galvanizado
Textura lisa, color blanco

Concrete with galvanized steel armor
Smooth texture, white

Béton avec armature acier galvanisé
Texture lisse, couleur blanc

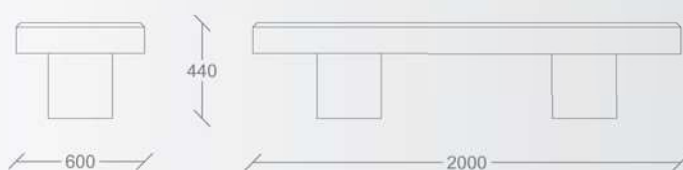

BANCOS / BENCHES / BANCS

Banco Ubiña 1500 Inox

Mod. B-001

Fabricado en granito natural y respaldo en acero inoxidable

Natural granite and stainless steel back

Granit naturel et de dos en acier inoxydable

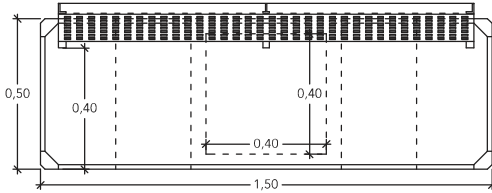

Banco Lousa 1500 Inox

Mod. B-002

Fabricado en granito natural y respaldo en acero inoxidable

Natural granite and stainless steel back

Granit naturel et de dos en acier inoxydable

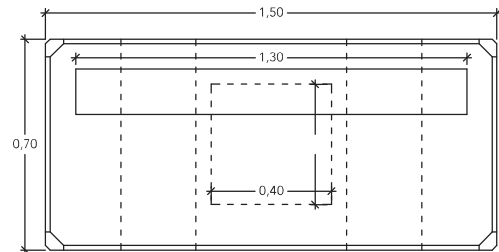

Banco Sagra

Mod. B-003

Fabricado en granito natural.

Natural granite.

Granit naturel.

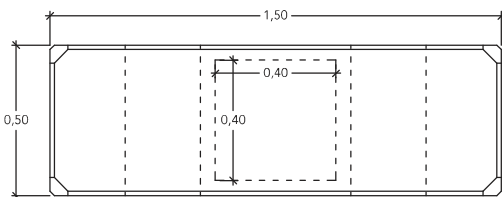

BANCOS / BENCHES / BANCS

E-PICNIC

Mod. E-PICNIC

Madera de pino autoclave, clase IV

Pine wood autoclave class IV

Bois de pin traité autoclave, classe IV

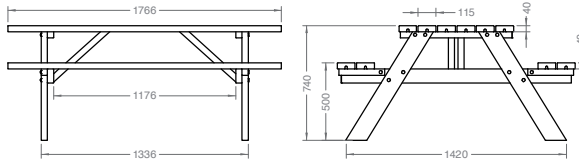

PAPELERA SALOU RÚSTICA



Mod. C-21S-PINO

Estructura de acero galvanizado
Madera de pino autoclave
Capacidad 60L

Galvanized steel structure
Autoclave pine wood
Capacity 60L

Structure en acier galvanisé
Bois de pin autoclave
Capacité 60L

PAPELERA CANADA RÚSTICA



Mod. C-2010-PC (55L) Mod. C-2010G-PC (80L)

Estructura de acero galvanizado
Madera de pino autoclave

Galvanized steel structure
Autoclave pine wood

Structure en acier galvanisé
Bois de pin autoclave



E-PICNIC TROPICAL

Mod. E-PICNIC-106

Madera tropical

Tropical wood

Bois tropical

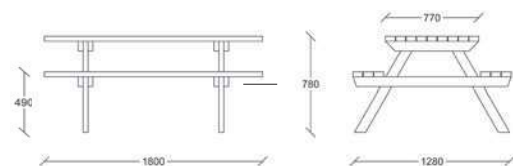

PAPELERA SALOU TROPICAL



Mod. C-21S

Estructura de acero galvanizado. Madera tropical
Capacidad 60L

Galvanized steel structure
Tropical wood
Capacity 60L

Structure en acier galvanisé
Bois tropical
Capacité 60L

PAPELERA CANADA TROPICAL



Mod. C-2010 (55L) Mod. C-2010G (80L)

Estructura de acero pintado
Madera tropical

Painted steel structure
Tropical wood

Structure en acier peint
Bois tropical

PAPELERAS

RUBBISH BINS / CORBEILLES



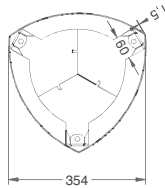
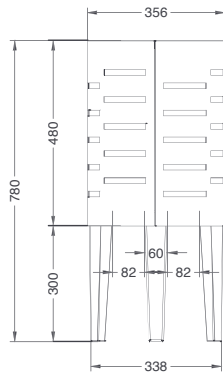

SCUDERIA

Mod. C-2009-ECO

Estructura chapa de acero
Acabado pintado en gris martelé
Capacidad 40L

Stell of steel structure
Paint finish with painted in grey hammer
Capacity 40L

Structure en tôle d'acier
Fini en peint en noir martele
Capacité 40L

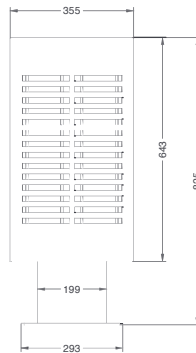

SCUDERIA

Mod. C-2009

Estructura de acero galvanizado
Acabado pintado en gris martelé
Capacidad 50L

Galvanized steel structure
Paint finish with painted in grey hammer
Capacity 50L

Structure en acier galvanisé
Fini en peint en noir martele
Capacité 50L



RADIAL

Mod. C-2013

Estructura de acero pintada en martelé. Se suministra con bolsa
Fácil control de contenido

Steel structure with black hammer paint. Bag supplied
Easy control of contents

Structure en acier peint noir martelé. Sac fourni
Contrôle facile des matières

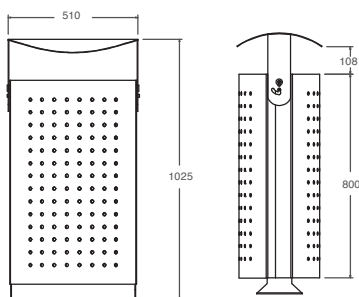
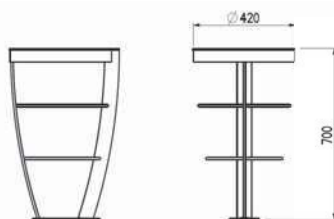

ARCO IRIS

Mod. C-2012

Estructura de acero galvanizado, tapa abatible y aro sujeta bolsa
Color gris martelé. Capacidad 85L

Galvanised steel structure, hinged lid and a ring to hold de bag
Black hammer paint. Capacity 85L

Structure en acier galvanisé, couvercle rabattable et anneau pour sacs
Peint noir martele. Capacité 85L



SPIRAL

Mod. C-2016

Chapa de acero galvanizada
Cubeta interior extraíble. Capacidad 65L
Color gris martelé

Galvanized steel structure
Inner bucket extraíble. Capacity 65L
Black hammer paint

Structure en acier galvanisé
Seau amovible. Capacité 65L
Peint noir martele

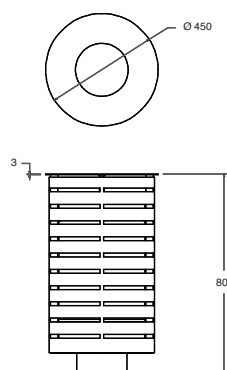

PORTALÓ

Mod. C-2001

Chapa de acero galvanizado con cierre
Cubeta interior extraíble. Color gris martelé
Capacidad 65L

Galvanized steel structure with lock
Inner bucket extraíble. Black hammer paint
Capacity 65L

Structure en acier galvanisé avec serrure de fermeture
Seau amovible. Peint noir martele
Capacité 65L



SCUDERIA POLIETILENO

Mod. C-2009-PLAST

Poliétileno, resistentes y económicas

Capacidad 60L

Ø 380 x 820 mm

High quality polyethylene, strong and economic

Capacity 60L

Ø 380 x 820 mm

Polyéthylène de haute qualité, résistant et économique

Capacité 60L

Ø 380 x 820 mm



RAL 5005

RAL 6029

COBALTO
SIMILAR RAL 5004

RAL 7021

RAL 3020

CORTEN
SIMILAR RAL 8017



100% RECICLABLE

Papelera Urbana

**SIN MANTENIMIENTO
RESISTENTE**

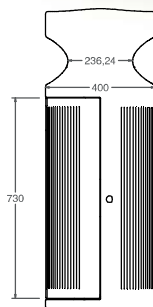
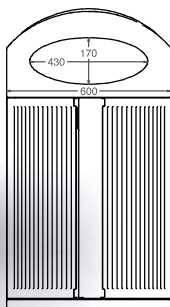

IBIZA PLAST

Mod. P-23I

Polietileno, resistentes y duradera
Capacidad 80L
400 x 600 x 1090 mm

High quality polyethylene, strong and durable
Capacity 80L
400 x 600 x 1090 mm

Polyéthylène de haute qualité, résistant et durable
Capacité 80L
400 x 600 x 1090 mm

100% RECICLABLE



RAL 5005

RAL 7021

RAL 3020

CORTEN
SIM. RAL 8017

NARANJA
SIM. RAL 2004

RAL 6029

VERDE ACIDO
SIM. RAL 1026

COBALTO
SIM. RAL 5004



RAL 3020

TOSCANA

Mod. P-200

Polietileno, resistentes y económicas
Capacidad 60L
410 x 410 x 850 mm

High quality polyethylene,
strong and economic
Capacity 60L
410 x 410 x 850 mm

Polyéthylène de haute qualité,
résistant et économique
Capacité 60L
410 x 410 x 850 mm



RAL 7021



RAL 1021



RAL 6029



RAL 5005

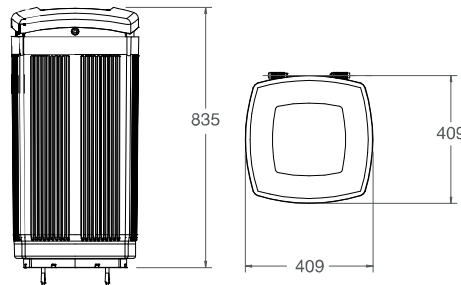

RAL 5005

LUCENTUM

Mod. P-201

Papelera fabricada en Polietileno de Alta Densidad
Especial para exteriores y con tratamiento UV
Capacidad 55L
Ø 410 x 850 mm

Bin made of high density polyethylene
Specially for outdoor and UV protection
Capacity 55L
Ø 410 x 850 mm

Corbeille fabriqué en polyéthylène haute densité
Extérieur spécial et avec traitement UV
Capacité 55L
Ø 410 x 850 mm



RAL 3020



RAL 6032



RAL 1021



RAL 7024

LUCENTUM 3 REICLABLE

Mod. P-201-REC

Papelera fabricada en Polietileno de Alta Densidad
Especial para exteriores y con tratamiento UV
Capacidad total 165L

Bin made of high density polyethylene
Specially for outdoor and UV protection
Total capacity 165L

Corbeille fabriqué en polyéthylène haute densité
Extérieur spécial et avec traitement UV
Capacité total 165L



100% RECICLABLE



TRAMONTANA

Mod. C-23F

Fundición ductil
Capacidad 60L

Ductile cast iron
Capacity 60L

Fonte ductile
Capacité 60L

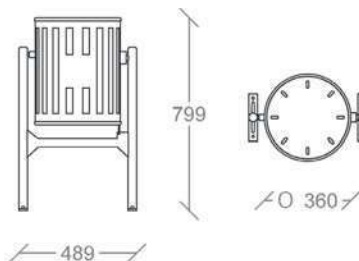

TRAMONTANA SEMICIRCULAR

Mod. C-23FM

Fundición ductil
Abatible con cierre
Capacidad 31L

Ductile cast iron
Hinged locking
Capacity 31L

Fonte ductile avec fermeture
Capacité 31L

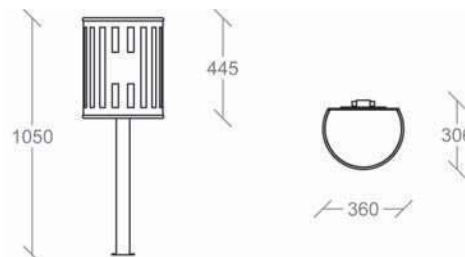

COLLSEROLA

Mod. C-2020

Fundición
Abatible y con cierre
Capacidad 160L

Cast iron
Hinged locking
Capacity 160L

Fonte
Avec fermeture
Capacité 160L

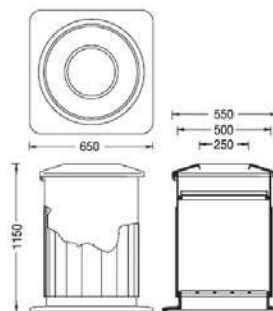



BARCELONA

- Mod. C-23G
- Mod. C-23G-70
- Mod. C-23GP
- Mod. C-23M
- Mod. C-23GC
- Mod. C-23GT

Cubeta galvanizada y pintada al horno RAL 7011

Galvanized steel powder coated finish RAL 7011

Acier galvanisé peint RAL 7011

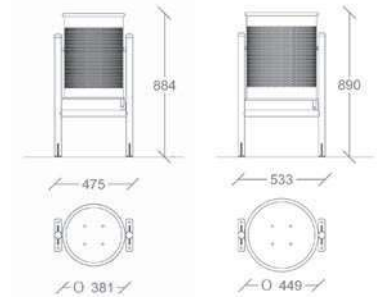

Mod. C-23G

Mod. C-23G-70

- ◀ **Mod. C-23G**
Capacidad 60L / Capacity 60L / Capacité 60L
- Mod. C-23G-70**
Capacidad 70L / Capacity 70L / Capacité 70L
- Mod. C-23GP**
Capacidad 50L / Capacity 50L / Capacité 50L

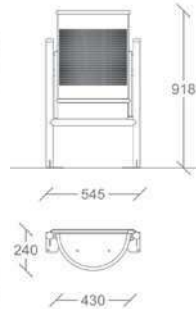

▲ **Mod. C-23M**

Capacidad 30L / Capacity 30L / Capacité 30L

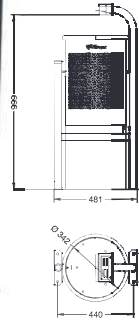

▲ **Mod. C-23GC**

Con cenicero / With ashtray / avec cendrier

Capacidad 60L / Capacity 60L / Capacité 60L

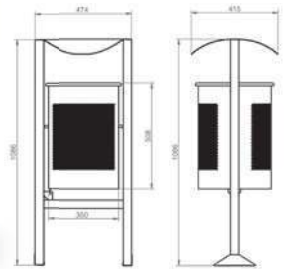

▲ **Mod. C-23GT**

Con sombrero / With top cover / avec couvercle

Capacidad 60L / Capacity 60L / Capacité 60L



BARCELONA INOX

- Mod. C-23X
- Mod. C-23MX semicircular

Acero inoxidable

Stainless steel

Acier inoxydable

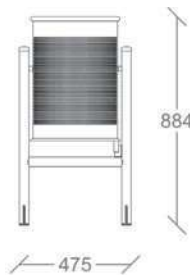

◀ **Mod. C-23X**

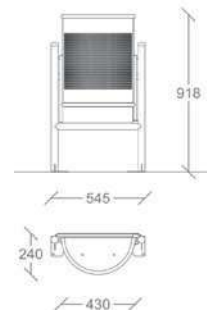

▲ **Mod. C-23MX semicircular**

Capacidad 30L / Capacity 30L / Capacité 30L

TENERIFE

Mod. C-21

Mod. C-21D (doble)

Mod. C-21-FA

(para colgar en farola o pared / To hang on a wall or streetlight / Pour accrocher au mur)

Mod. C-21-T

(con sombrero / With top covert / avec couvercle)

Plancha embutida y pintada al horno
Capacidad 40L

Inlaid iron
Powder coated finish
Capacity 40L

Acier embouti
Finition peint au four
Capacité 40L



Mod. C-21



Mod. C-21-T

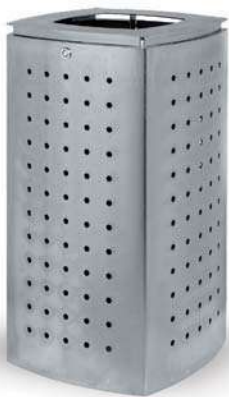
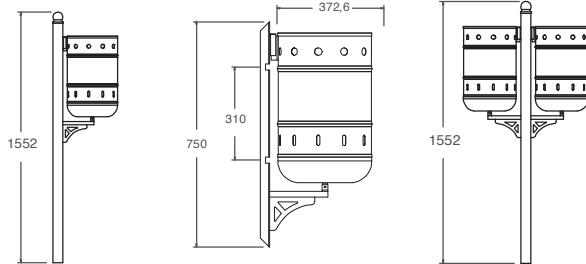

AMG

Mod. C-2004

Chapa de acero galvanizado y pintada color plata
Tapa con cierre y cubeta interior extraíble
Capacidad 60L

Galvanized and powdercoated finished silver
Cover with lock and inner bucket extractable
Capacity 60L

Structure en acier galvanisé et peint argent
Couvercle verrouillable et seau amovible
Capacité 60L

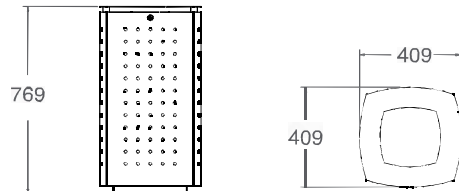

COSTA

Mod. C-2002

Chapa de acero galvanizado pintada color plata y madera tropical
Tapa con cierre y cubeta interior extraíble
Opcional: Estructura de acero pintada en oxirón

Galvanized and powdercoated finished silver and tropical wood
Cover with lock and inner bucket extractable
Optional: Steel structure powder coated with oxiron paint

Structure en acier galvanisé peint argent et bois tropical
Couvercle verrouillable et seau amovible
En option: Structure en acier peint oxiron

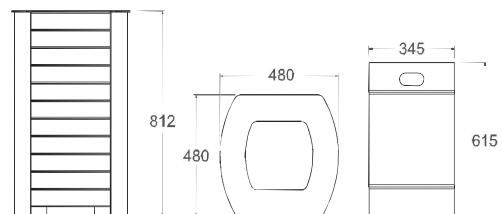



CERDANYOLA

Mod. C-21C

Chapa de acero galvanizada y pintada color plata
Capacidad 60L

Galvanized and painted in silver steel structure
Capacity 60L

Structure en acier galvanisé et peint couleur argent
Capacité 60L

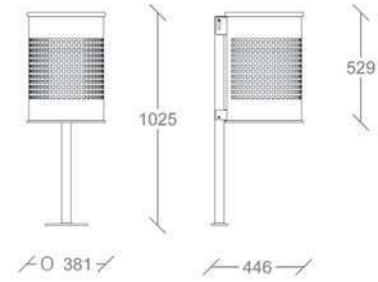

ANTIBOMBA

Mod. C-2011

Estructura inoxidable
Facil control de contenido
Se suministra sin bolsa

Stainless steel structure
Easy control of contents
Bag not supplied

Structure inox
Contrôle facile des matières
Sac non fourni

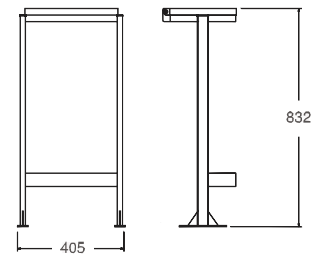

MARGARITA

Mod. C-2007

Acero con cubeta interior extraíble
Capacidad 65L

Steel with inner bucket extractable
Capacity 65L

Acier avec seau amovible
Capacité 65L

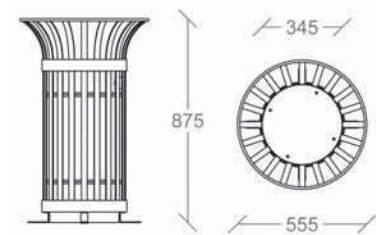

URBAN

Mod. C-24PC

Poliétileno
Capacidad 55L
Opcional: C-24PP con poste galvanizado

Polyethylene
Capacity 55L
Optional: C-24PP with galvanized stick

Polyéthylène
Capacité 55L
En option: C-24PP avec barre galvanisé

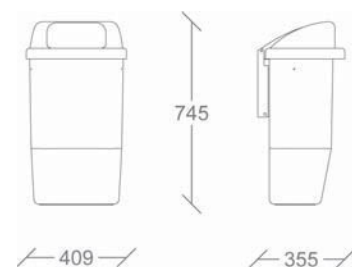



CANADA RÚSTICA

Mod. C-2010-PC (55L)
Mod. C-2010G-PC (80L)

Estructura de acero pintado
Madera de pino autoclave

Painted steel structure
Autoclave pine wood

Structure en acier peint
Bois de pin autoclave

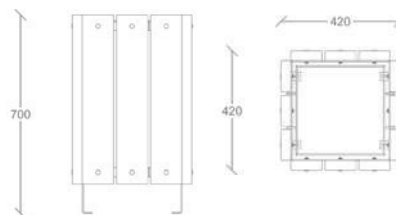

CANADA TROPICAL

Mod. C-2010 (55L)
Mod. C-2010G (80L)

Estructura de acero pintado
Madera tropical

Painted steel structure
Tropical wood

Structure en acier peint
Bois tropical

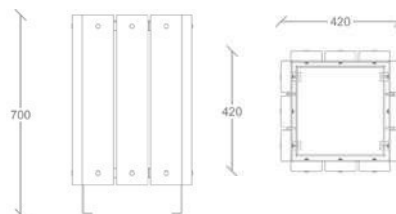

SALOU RÚSTICA

Mod. C-21S-PINO

Estructura de acero galvanizado
Madera de pino autoclave
Capacidad 60L

Galvanized steel structure
Autoclave pine wood
Capacity 60L

Structure en acier galvanisé
Bois de pin autoclave
Capacité 60L

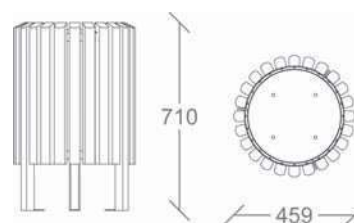

SALOU TROPICAL

Mod. C-21S

Estructura de acero galvanizado
Madera tropical
Capacidad 60L

Galvanized steel structure
Tropical wood
Capacity 60L

Structure en acier galvanisé
Bois tropical
Capacité 60L

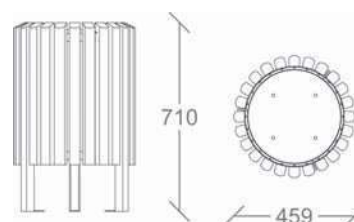



VALLADOLID

Mod. C-20

Estructura de acero pintado
Madera tropical
Capacidad 40L

Painted steel structure
Tropical wood
Capacity 40L

Structure en acier peint
Bois tropical
Capacité 40L

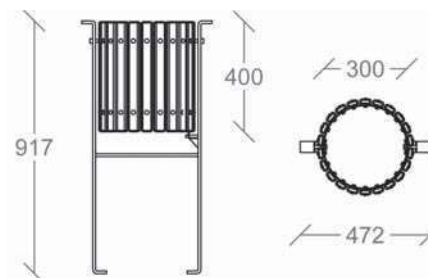

TARRAGONA

Mod. C-2017

Listones de madera tropical
Estructura de acero galvanizado
Capacidad: 60 L

Slats of tropical wood
Structure of galvanized steel
Capacity: 60 L

Voliges de bois tropical
Structure dans acier galvanisé
Capacité: 60 L

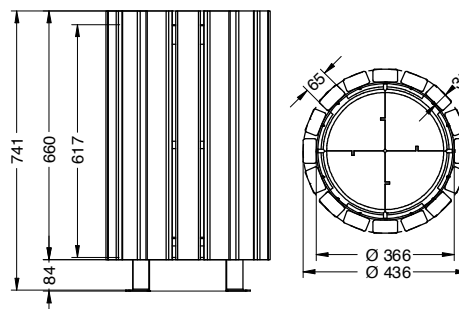

JARDINERAS

PLANTERS / JARDINIERES





ONA RECTANGULAR

Mod. J-18 / 100x35 cm

Fundicion ductil pintado en oxiron

Ductile cast iron oxiron painted

Fonte peint oxiron

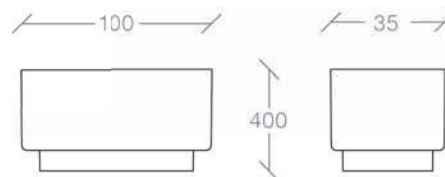

ONA RECTANGULAR-75

Mod. J-18-75 / 75x45 cm

Fundicion ductil pintado en oxiron

Ductile cast iron oxiron painted

Fonte peint oxiron

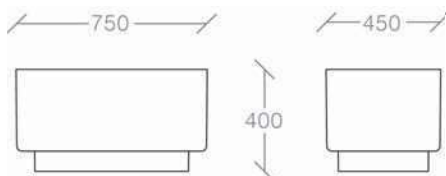

ONA CUADRADA

Mod. J-18-70 / 70x70 cm

Fundicion ductil pintado en oxiron

Ductile cast iron oxiron painted

Fonte peint oxiron

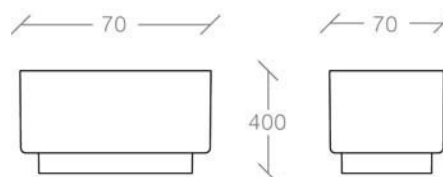



BARCELONA

J-1 Ø135 cm / J-2 Ø90 cm

Fundición ductil pintado en oxirón

Ductile cast iron oxiron painted

Fonte peint oxiron

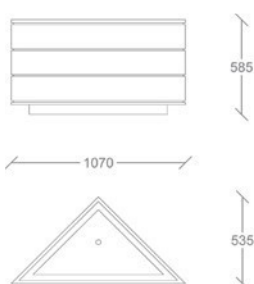
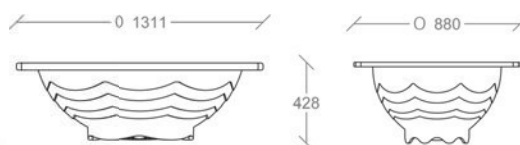

AQUALATA

Mod. J-4

Fundición pintado en oxirón

Cast iron oxiron painted

Fonte peint oxiron

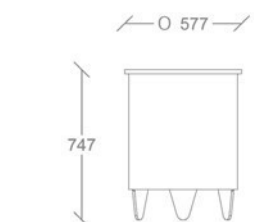

CASTELLAR

Mod. J-15

Fundición pintado en oxirón

Cast iron oxiron painted

Fonte peint oxiron

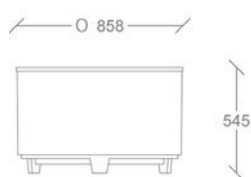

CLAUDIA

Mod. J-33

Fundición pintado en oxirón

Cast iron oxiron painted

Fonte peint oxiron

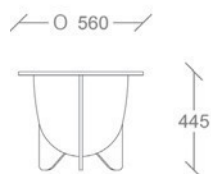

GNOMO

Mod. J-32

Fundición pintado en oxirón

Cast iron oxiron painted

Fonte peint oxiron

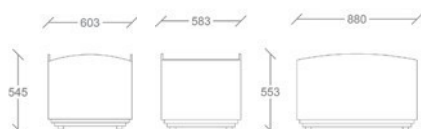

VALLADOLID

Mod. V-1 / Mod. V-2

Fundición pintado en oxirón

Cast iron oxiron painted

Fonte peint oxiron



DORI

Mod. J-19

Estructura de acero pintada al horno

Steel structure powder coated finish

Structure en acier peint au four

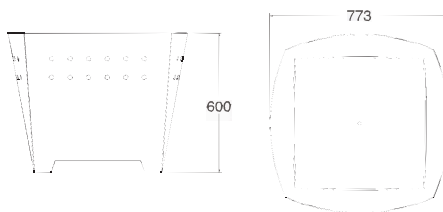

CUBE

Mod. J-16

Estructura de acero pintada al horno

Steel structure powder coated finish

Structure en acier peint au four

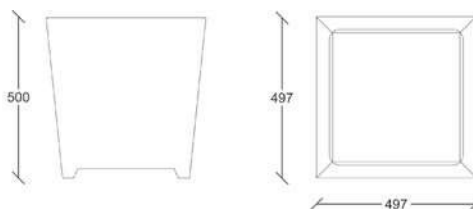

SOLEDAT

Mod. J-13

Acero corten oxidado. Barandilla acero inox

Rusty steel corten. Stainless steel railing

Structure acier oxydé. Rambarde en acier inoxydable

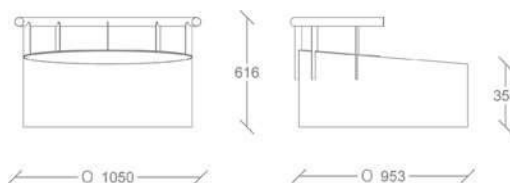

DIAGONAL

Mod. J-51

Acero corten oxidado

Rusty steel corten

Structure acier oxydé

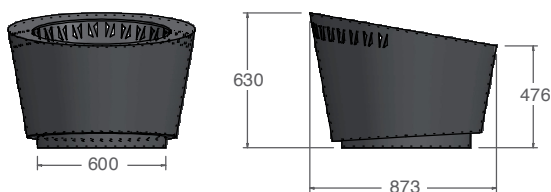



NEWPORT

Mod. J-9

Estructura galvanizada y madera de guinea
Galvanized steel structure and tropical wood
Structure d'acier galvanisé et bois tropical

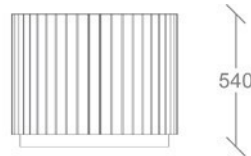

NEWPORT

Mod. J-9M

Estructura galvanizada y madera de pino autoclave
Galvanized steel structure and autoclave pine wood
Structure d'acier galvanisé et bois de pin

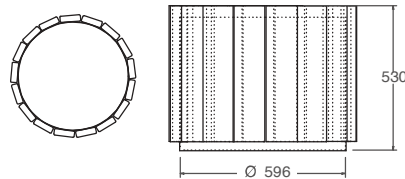

RAL 5011

FUTURA

Mod. P-300

Polietileno, resistentes y económicas.
Ø 1000 x 500

High quality polyethylene, strong and economic. Ø 1000 x 500

Polyéthylène de haute qualité, résistant et économique. Ø 1000 x 500

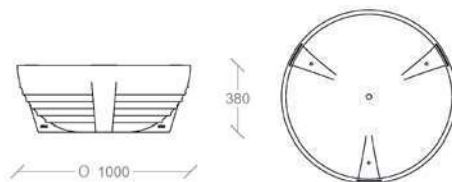

RAL 3020

RAL 7021

CORTEN
SIM. RAL 8017

VERDE ACIDO
SIM. RAL 1026



RAL 5005

RAL 6029

NARANJA
SIM. RAL 2004

FUENTES

FOUNTAINS / FONTAINES



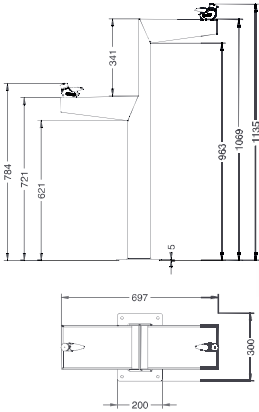

MINUS

Mod. V-102

Acero inoxidable y acero pintado en gris martelé
Adaptado para minusválidos. Grifos pulsadores temporizados

Stainless steel and steel painted in black hammer paint
Adapted for disabled. Timed taps

Acier inoxydable et acier peint noir martelé
Spécial handicapés. Robinets temporisèe

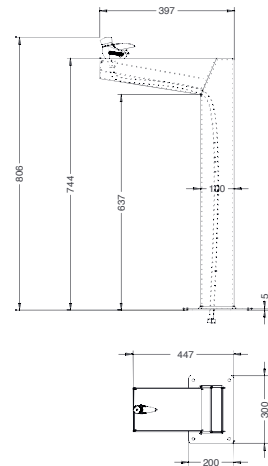

MINIMINUS

Mod. V-102M

Acero inoxidable y acero pintado en gris martelé
Adaptado para minusválidos. Grifo pulsador temporizado

Stainless steel and steel painted in black hammer paint
Adapted dor disabled. Timed tap

Acier inoxydable et acier peint noir martelé
Spécial handicapés. Robinet temporisèe

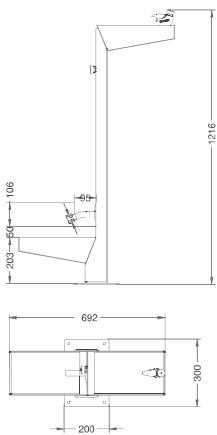

MINUS DOG

Mod. V-102D

Acero inoxidable y acero pintado en gris martelé
Para personas y mascotas. Grifos pulsadores temporizados

Stainless steel and steel painted in black hammer paint
For people and pets. Timed taps

Acier inoxydable et acier peint noir martelé
Pour personnes et animaux. Robinets temporisèe





RAL 5005

VERDE ACIDO
SIMILAR RAL 1026

COBALTO
SIMILAR RAL 5004

RAL 3020

RAL 7021

NARANJA
SIMILAR RAL 2004

CORTEN
SIMILAR RAL 8017

RAL 6029



FUENTE ALVIUM

Mod. V-1017

Fuente fabricada en Polietileno de media densidad
Especial para exteriores y con tratamiento UV
2 grifos o 1 grifo
Ø 450 x 1000 mm

Fountain made of medium density polyethylene
Specially for outdoor and UV protection
2 taps or 1 taps
Ø 450 x 1000 mm

Fontaine fabriqué en polyéthylène moyenne densité
Extérieur spécial et avec traitement UV
2 robinets ou 1 robinet
Ø 450 x 1000 mm



100% RECICLABLE



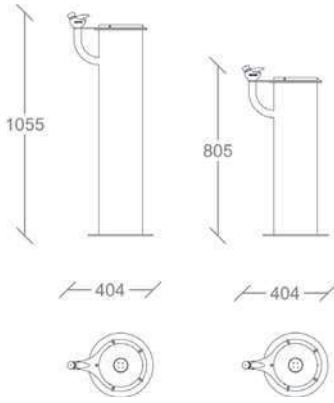

ESVA

Mod. V-109 / Mod. V-109M (infantil)

Totalmente en acero inoxidable
Grifo pulsador temporizado

All stainless steel
Timed tap

Fontaine inox.
Robinet temporisee

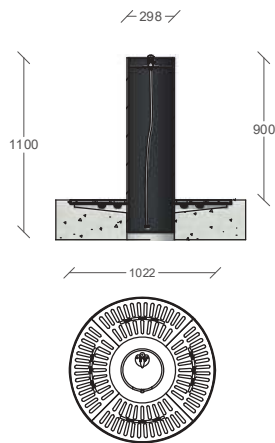

VILLA OLÍMPICA

Mod. V-101

Acero pintado en oxiron, cubeta en acero inoxidable. Grifo pulsador temporizado

Oxiron painted steel,
Stainless steel deck. Timed tap

Acier peint oxiron,
Bac en acier inoxydable. Robinet temporisee

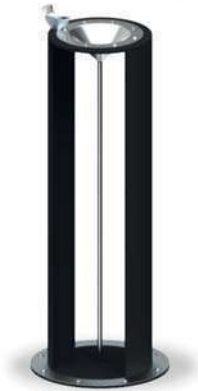
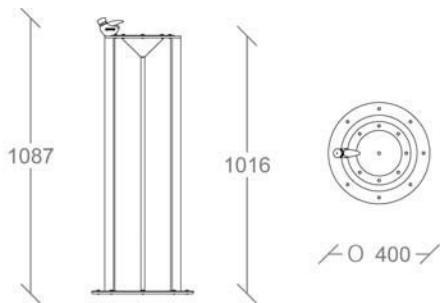

SPUTNIK

Mod. V-3102

Estructura de acero pintado al horno y inoxidable
Grifo pulsador temporizado

Powder coated structure and stainless steel
Timed tap

Structure en acier peint au four
Robinet temporisee

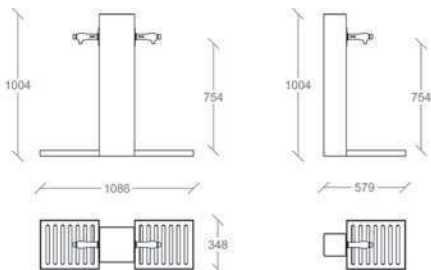

GALDANA

**Mod. C-14
Mod. C-14-FU
Mod. C-14D**

Acero pintado gris martelé y reja de acero galvanizado
Opcional con reja de fundición
Grifo pulsador temporizado

Black hammer paint and galvanized grill
Cast iron optional grill
Timed tap

Acier peint en noir martele au four avec grille en acier galvanisé
Option grille en fonte
Robinet temporisee

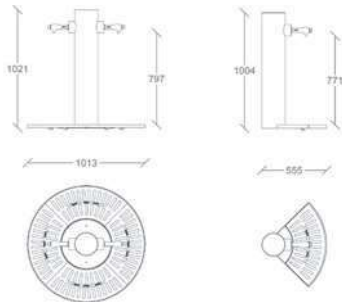

VENDÔME

Mod. C-15-CROM-RE
Mod. C-15-CROM-FU
Mod. C-15CD-CROM

Acero pintado gris martelé y reja de acero galvanizado
Opcional con reja de fundición
Grifo pulsador temporizado

Black hammer paint and galvanized grill
Cast iron optional grill
Timed tap

Acier peint en noir martelé au four avec grille en acier galvanisé
Option grille en fonte
Robinet temporisée

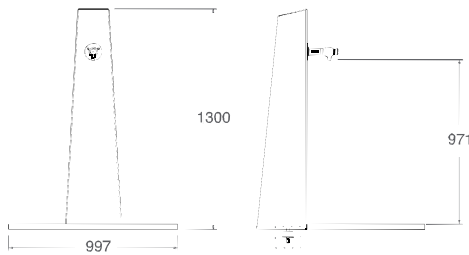

BEU

Mod. C-3100

Acero pintado oxiron y reja de acero galvanizado
Grifo pulsador temporizado

Powder coated oxiron and galvanized grill
Timed tap

Acier peint oxiron au four avec grille en acier galvanisé
Robinet temporisée

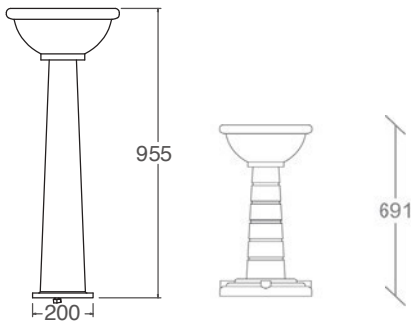

Mod. C-12A

Mod. C-12

INFANTIL

Mod. C-12 / C-12A

Fundición con 1 grifo vertical de chorro continuo

Cast iron with 1 vertical tap with continuous jet

Fonte avec 1 robinet vertical à jet continu

Opcional / Optional / En option
GRIF-PIE

Pulsador de pie temporizado encastable

Timed footswitch encastable

Robinet de pied intégré

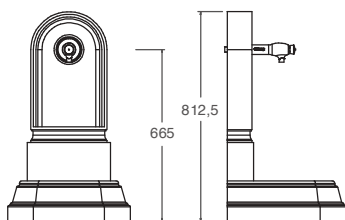

PORTAL

Mod. C-11

Fundición pintado oxiron

Cast iron oxiron paint

Fonte peint oxiron

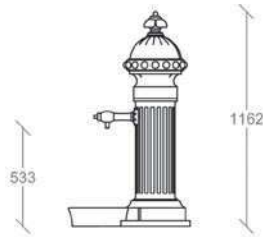

ROMÁNTICA

Mod. C-10

Mod. C-10A 2 grifos / 2 vertical tap / 2 robinets

Mod. C-10B 3 grifos / 3 vertical tap / 3 robinets

Mod. C-10C 4 grifos / 4 vertical tap / 4 robinets

Fundición pintado oxiron

Cast iron oxiron paint

Fonte peint oxiron

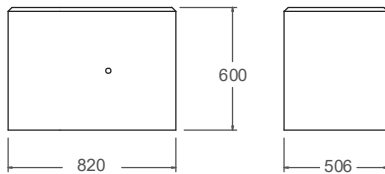

Opcional / Optional / En option E-PEANA

Base de hormigón

Concrete base

Base de béton

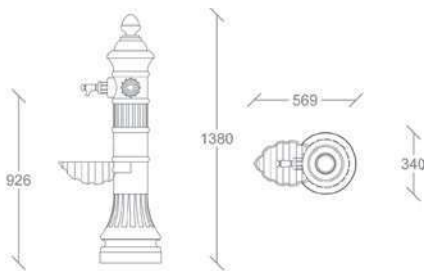

CASTELLANA

Mod. C-17

Fundición pintado oxiron

Cast iron oxiron paint

Fonte peint oxiron

GRIFO

Mod. GRIF-10

Fabricado en latón. Pulsador temporizado a 7 segundos

Made of brass. Timed to 7 seconds

Robinet en laiton. Temps d'écoulement réglé à 7 secondes



GRIFO

MOD. GRIF-10 CROM

Fabricado en latón cromado. Pulsador temporizado a 7 segundos

Made of brass chrome. Timed to 7 seconds

Robinet en laiton chromé. Temps d'écoulement réglé à 7 secondes



ALCORQUES

TREE GRILLS / ENTOURAGES



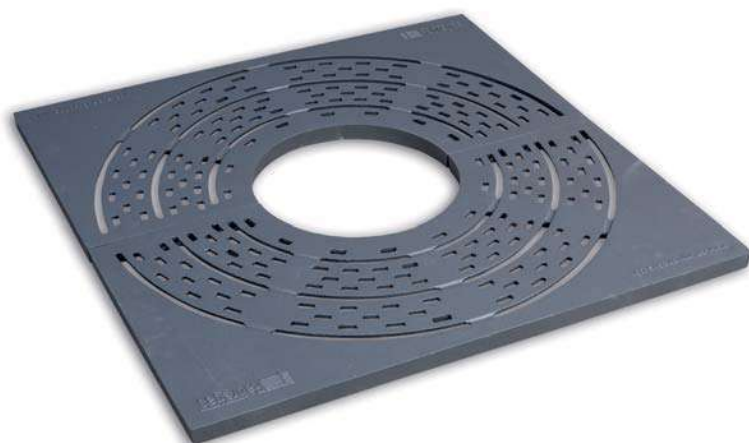

NIU

Mod. I-700-80
Mod. I-700-100

Fundición dúctil. Acabado oxirón negro. Agujeros < 10mm.

Ductile cast iron. Oxiron paint. Holes < 10mm.

Fonte ductile. Peint noir oxyron

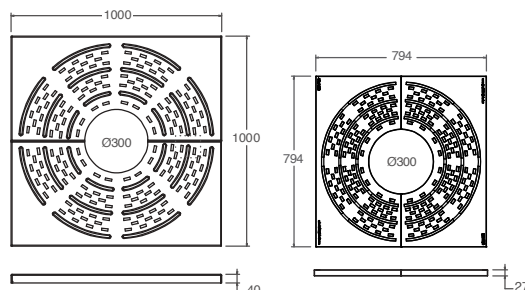

ESTADI

Mod. I-200
Mod. I-200-80

Fundición. Acabado oxirón negro
Opcional: Marco en fundición

Cast iron with oxiron paint
Option: Cast iron frame

Fonté. Peint noir oxyron
En option: Cadre en fonte

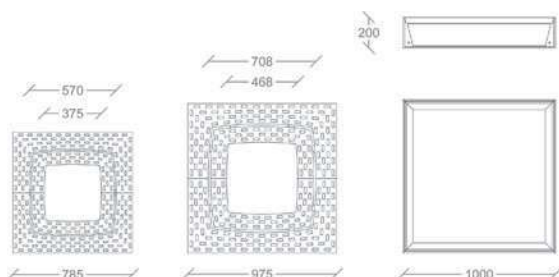
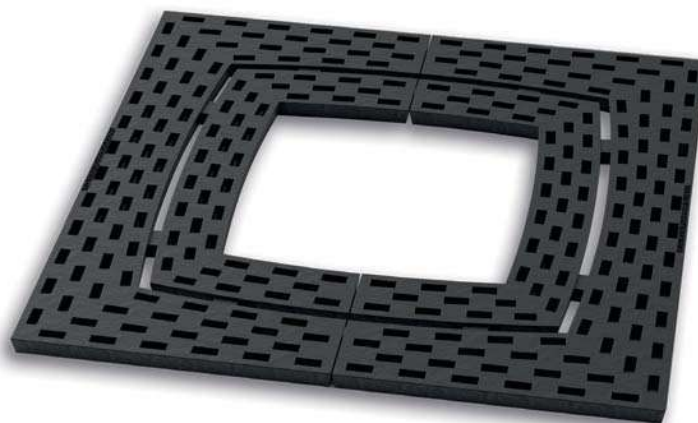

RADIAL

Mod. I-600

Fundición dúctil. Acabado oxirón negro

Ductile cast iron with oxiron paint

Fonte ductile. Peint noir oxyron

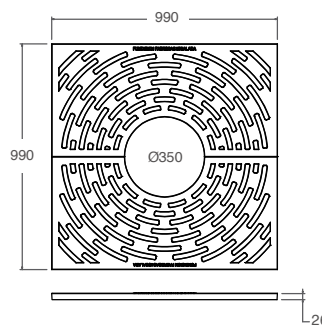

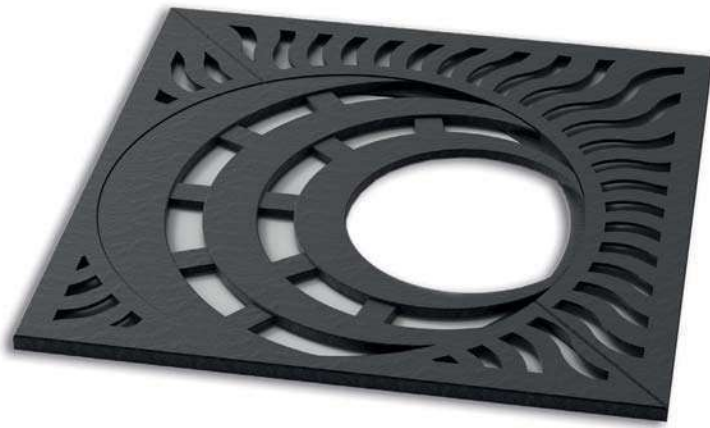

EXCENTRIC

Mod. I-100

Fundición dúctil. Acabado oxirón negro
En 3 piezas, multiposicional

Ductile cast iron with oxiron paint
3 pieces, multipositional

Fonte ductile. Peint noir oxylon
En 3 parties, multipositions

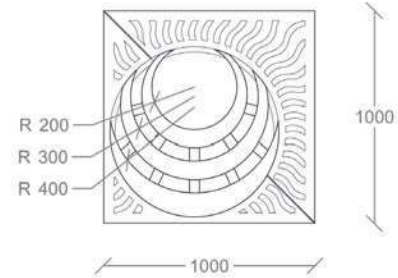

E-TEIXIDO

Mod. E-TEIXIDO-L80

Mod. E-TEIXIDO-L100

Mod. E-TEIXIDO-L120

Mod. E-TEIXIDO-L140

Fundición oxidada tipo Corten
4 laterales para formar un alcorque
Combinables entre ellos

Cast iron finished watering steel
4 pieces for made the frame
Possibility of different sizes

Cadre modulaire en fonte, finition rouille type Corten
4 côtés pour former a cadre
Multiple combinaisons

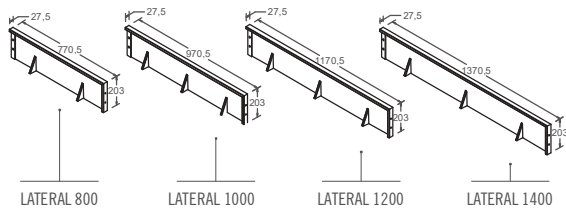

E-TEIXIDO

Mod. E-TEIXIDO-C100

Mod. E-TEIXIDO-C120

Fundición oxidada tipo Corten
4 laterales para formar un alcorque
2 diámetros: Ø 1000mm. / Ø1200mm.

Cast iron finished weathering steel
4 pieces for made the frame
2 diámetros: Ø 1000mm. / Ø1200mm.

Cadre modulaire en fonte, finition rouille type Corten
4 côtés pour former a cadre
2 diámetros: Ø 1000mm. / Ø1200mm.

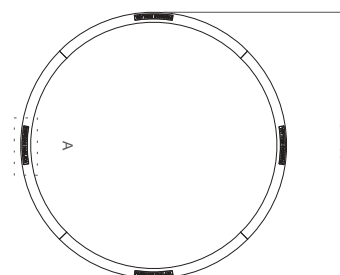

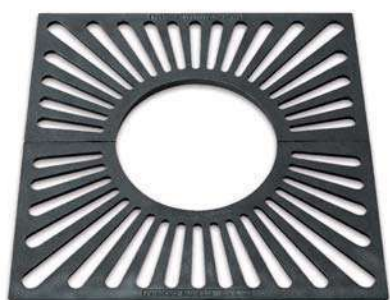
**CUADRADO**

Mod. C-48
Mod. C-49X

Fundición. Acabado oxirón negro

Cast iron with oxiron paint

Fonté. Peint noir oxylon

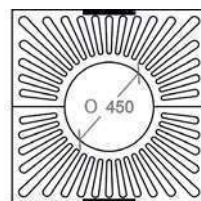

Mod. C-48

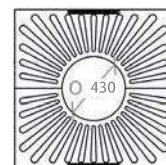

Mod. C-49X

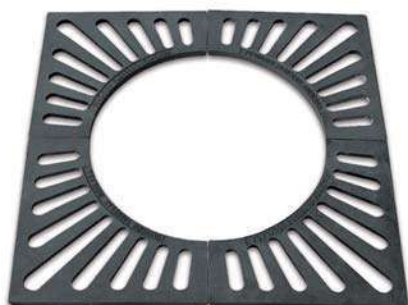
**CUADRADO**

Mod. C-49H

Fundición. Acabado oxirón negro

Cast iron with oxiron paint

Fonté. Peint noir oxylon

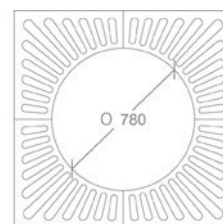

1192

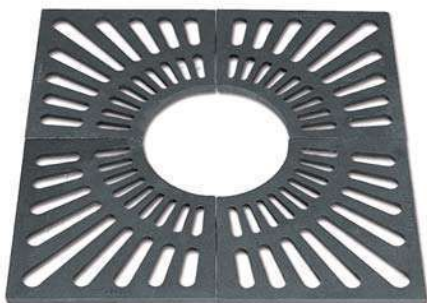
**CUADRADO**

Mod. C-49

Fundición. Acabado oxirón negro

Cast iron with oxiron paint

Fonté. Peint noir oxylon

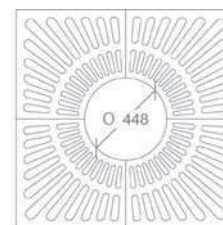

1192

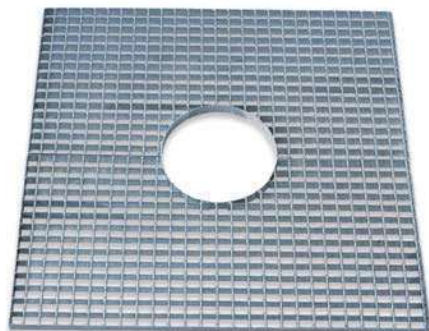
**RELIGA**

Mod. C-22 (500 x 500)
Mod. C-22A (600 x 600)
Mod. C-22B (700 x 700)
Mod. C-22C (800 x 800)
Mod. C-22D (900 x 900)
Mod. C-22E (1000 x 1000)
Mod. C-22F (1100 x 1100)
Mod. C-22G (1200 x 1200)

Acero galvanizado. De 3 cms de altura

Galvanized steel. Of 3 cms high

En acier galvanisé. 3 cms de haut

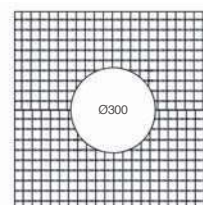



IMPU

Mod. I-300

Fundición. Acabado oxirón negro

Cast iron with oxiron paint

Fonté. Peint noir oxyron

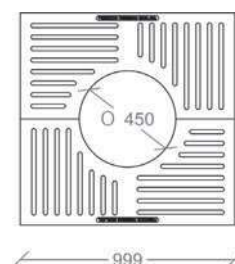

FIDENZA

Mod. I-400

Fundición. Acabado oxirón negro.
2 piezas y 4 registros para regar

Cast iron with oxiron paint.
2 pieces and 4 holes for irrigation

Fonté. Peint noir oxyron.
2 pièces et 4 trous pour l'irrigation

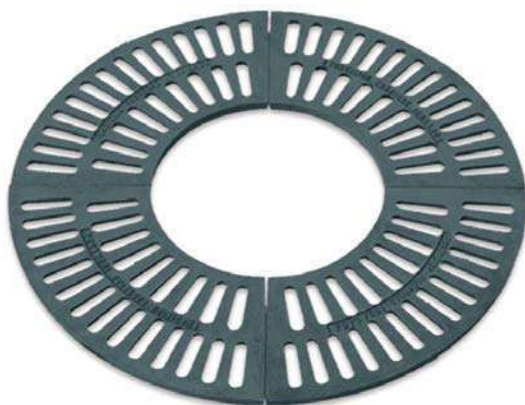
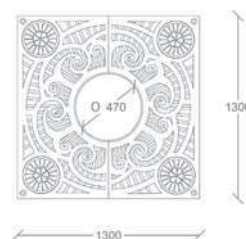

CIRCULAR

Mod. C-47
Mod. C-47B

Fundición. Acabado oxirón negro
2 piezas

Cast iron with oxiron paint
2 pieces

Fonté. Peint noir oxyron
2 pièces

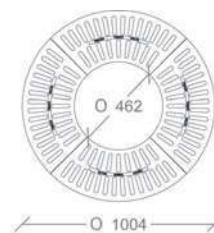

Mod. C-47B

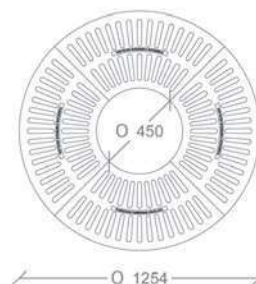

Mod. C-47

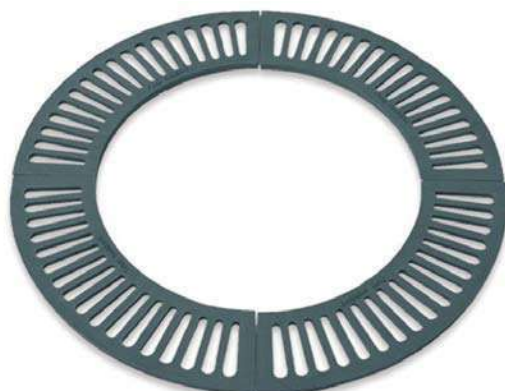

CIRCULAR

Mod. C-47A

Fundición. Acabado oxirón negro
2 piezas

Cast iron with oxiron paint
2 pieces

Fonté. Peint noir oxyron
2 pièces

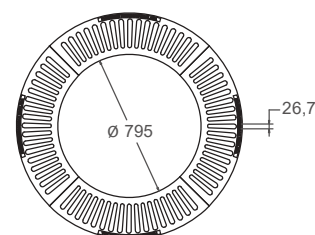

PILONAS

BOLLARDS / POTELETS



PILONAS / BOLLARDS / POTELETS

FLEXIBLE PARCIAL

PARTIALLY FLEXIBLE / PARTIELLEMENT FLEXIBLE

POLIPROPILENO

Mod. C-430

Absorbe impactos de vehículos y recupera la verticalidad al 100%

Flexible hasta 20° sin daños, recuperando la posición completamente

Flexión inteligente: no empieza a fletar hasta aplicarle cargas superiores a 150 kgs

Absorbing impacts of vehicles and recovering the verticality 100%

Flexible to 20 degrees without damage, RECOVERING the fully position

Smart Flex: no flex starts to apply loads exceeding 150 kgs

Impacts des véhicules absorbants et la récupération de la verticalité 100%

Flexible à 20 degrés sans dommage, la récupération complète

Intelligente Flex: pas de flet commence à applique des charges supérieures à 150 kgs



C-430

C-430-ROJ
RAL 3020

C-430-AZU
RAL 5005

C-430-AMA
RAL 1021

C-430-VER
RAL 6029

100% RECICLABLE



Producto certificado



PILONAS / BOLLARDS / POTELETS



Parques y Jardines Fábregas S.A.U.

FLEXIBLE TOTAL

FULLY FLEXIBLE / ENTIÈREMENT FLEXIBLE

POLIURETANO

Mod. C-430-TPU

Para zonas peatonales convencionales
Flexible total sin daños
Carga hasta 150 kg
Sin mantenimiento
Medidas: 100 x 996 mm

For conventional pedestrian areas
Total flexible without damage
Load up to 150 kg
Non maintenance
Measures: 100 x 996 mm

Pour zones piétonnes classiques
Total flexible sans dommage
Charge jusqu'à 150 kg
Aucun entretien
Mesures: 100 x 996 mm



C-430-TPU

C-430-TPU GRIS

C-430-TPU-ROJ RAL 3020

C-430-TPU-AZU RAL 5005

C-430-TPU-AMA RAL 1021

C-430-TPU-VER RAL 6029



Videos: <https://youtu.be/siPI0qIn5tc>
<https://youtu.be/awUYdnZmCTc>

Producto certificado



Nº: CP-22-16-101-01

100% RECICLABLE



FLEXIBLE TOTAL

FULLY FLEXIBLE / ENTIÈREMENT FLEXIBLE



POLIURETANO

Mod. C-430-TPU PLUS

Supera una flexión de 1500 ciclos a 45° y 50 ciclos a 90°, sin daños (Informe 16-31705992 emitido por LGAI Technological Center).
Clasificación "E" de comportamiento al fuego, según norma UNE-EN 13501-1:2007+A1:2010, y ensayo según norma UNE-EN 13238:2011 (Informe 16/13069-1884 parte 1 y 2 realizado por LGAI Technological Center)
Resistente a -50° según norma UNE ISO 812 (Informe 16/31707091 realizado por LGAI Technological Center).
Conforme a la norma UNE EN 1176/1:2009

It surpasses a flexion of 1500 cycles at 45° and 50 cycles at 90°, without damages (Report +16-31705992 Issued by LGAI Technological Center).
Fire classification "E" according UNE-EN 13501-1: 2007 + A1: 2010, and test according UNE-EN 13238: 2011 (Report 16 / 13069-1884 part 1 and 2 carried out by LGAI Technological Center).
Resistant to -50° according UNE ISO 812 standard (Report 16/31707091 by LGAI Technological Center).
According the standard UNE EN 1176/1: 2009

Dépasse une flexion de 1500 cycles au 45° et 50° cycles au 90°, sans dommages (rapport 16-31705992 emis par LGAI Technological Center)
Classification "E", de comportement au feu, selon norme UNE-EN13501-1:2007+A1:2010, et essai selon norme UNE-EN 13238:2011 (rapport 16/13069-1884 part 1 et 2 réalisé par LGAI Technological Center)
Résistant au -50° selon norme UNE ISO812 (rapport 16/31707091 réalisé par LGAI Technological Center). Selon la norme UNE EN 1176/1:2009

Fábregas

100% RECICLABLE

Producto certificado



Mod. P-41P
Para atornillar

Flexible 20°

FLEXBOOK - POLIPROPILENO

Para zonas peatonales conflictivas
Flexible total. Recupera siempre verticalidad sin daños
Carga hasta 80 Kg
Sin mantenimiento

For conflicting pedestrian areas
Total flexible. Always recover verticality, without damage
Load up to 80 Kg
Non maintenance

Pour zones piétonnes contradictories
Total Flexible. Récupérez toujours la verticalité sans dommage
Charge jusqu'à 80 Kg
Aucun entretien

PILONAS / BOLLARDS / POTELETS



▲ **ONA**
Mod. C-516



▲ **SALT**
Mod. C-507
Mod. C-507G

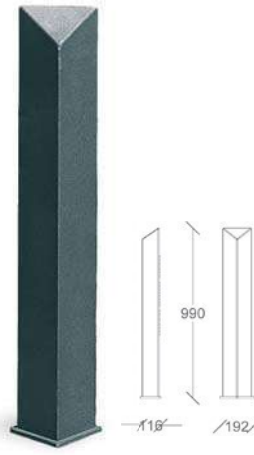

▲ **AQUALATA**
Mod. C-508



▲ **TRANG**
Mod. C-505



▲ **TON**
Mod. C-503M



▲ **TON**
Mod. C-503
Mod. C-503G

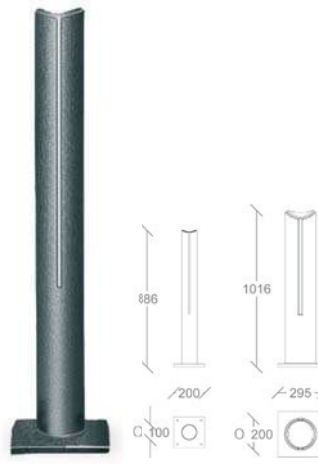

▲ **BADALONA**
Mod. C-45E
Mod. C-45G



▲ **SANTFELIU**
Mod. C-41
Mod. C-41P

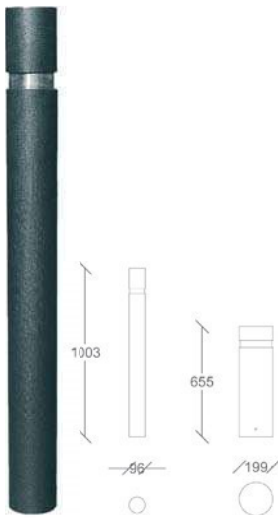

▲ **BARCELONA 2**
Mod. C-43
Mod. C-43G



▲ **SANT CUGAT**
Mod. C-522
Mod. C-522G

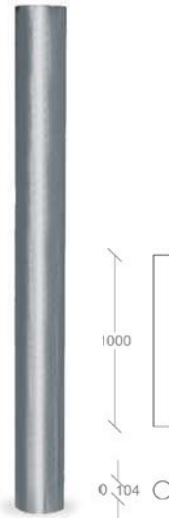

▲ **MONTREAL**
Mod. C-500

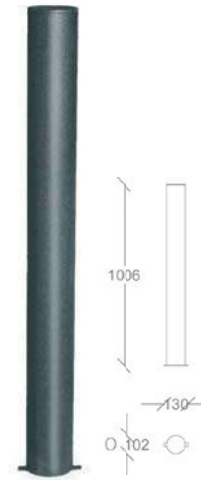

▲ **TUBO**
Mod. C-502

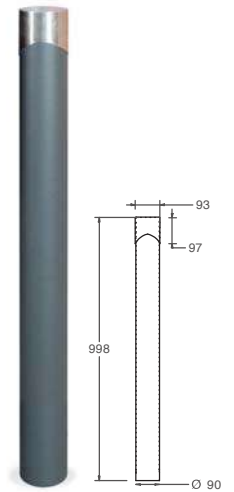

▲ **DUNA**
Mod. C-525



▲ **PALMA DE MALLORCA**
Mod. C-45P

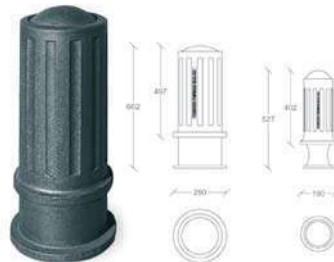

▲ **VÍA JULIA**
Mod. C-40
Mod. C-40P

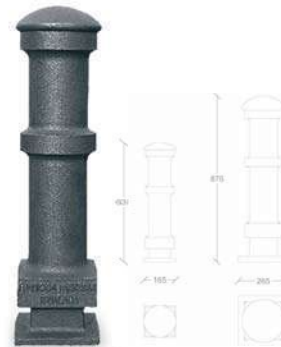

▲ **BARCELONA**
Mod. C-42
Mod. C-42P

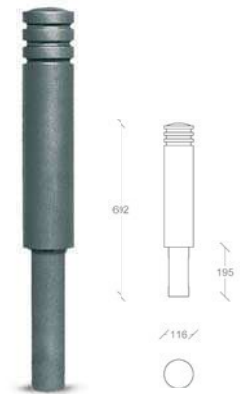

▲ **ALCALÁ**
Mod. C-601



▲ **PILONA GREY**
Mod. C-517

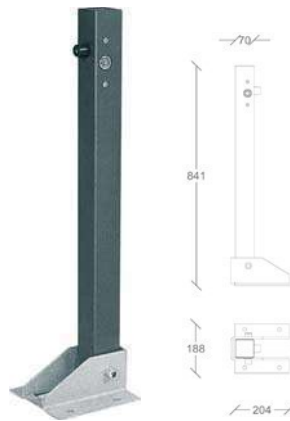

▲ **PARKING ABATIBLE**
Mod. P-A

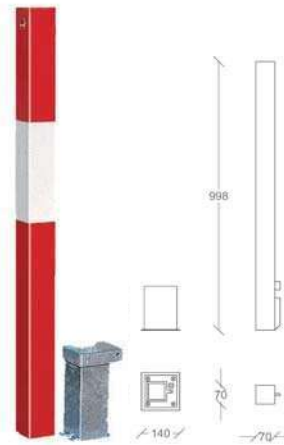

▲ **PARKING EXTRAIBLE**
Mod. P-E

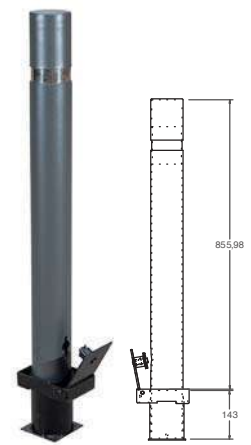

▲ **ECO**
Mod. C-43D-ECO

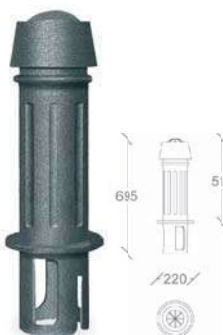

▲ **NORTE**
Mod. C-45N

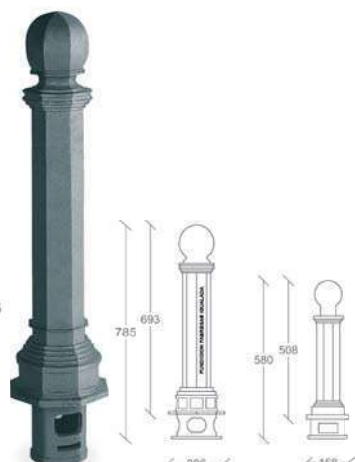

▲ **VALENCIA ANTIGA**
Mod. C-45A
Mod. C-45AP

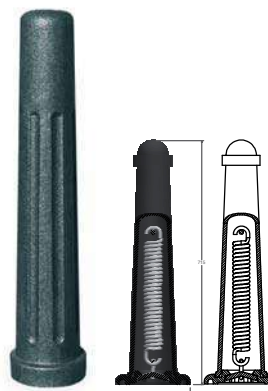

▲ **FLEXIPILONA PALMA DE MALLORCA / SANT FELIU**
Mod. C-45PF
Mod. C-41PF

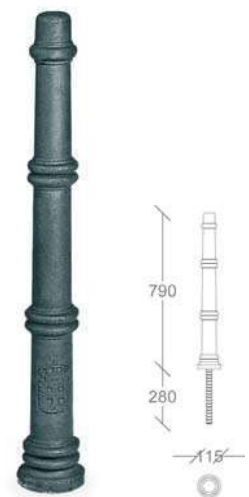

▲ **MADRID**
Mod. C-509

PILONAS / BOLLARDS / POTELETS



▲ CANARIAS
Mod. C-514



▲ CIBELES
Mod. C-602



▲ ESFERA
Mod. C-44
Mod. C-44A

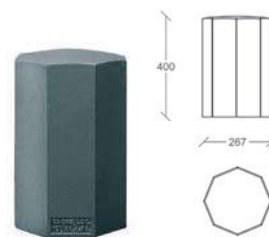

▲ CALIVIÀ
Mod. C-515



▲ MARSELLA
Mod. C-45M



▲ GIRONA
Mod. C-45C



▲ VALENCIA NOVA
Mod. C-46



▲ AMARRES
Mod. A-700

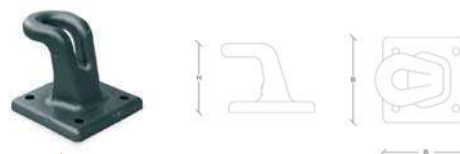

▲ NORAY BADALONA
Mod. A-711 / Mod. A-712 / Mod. A-714



◀ BASE VARIO-500

Base desmontable sin tapa / Removable base uncovered / Base amovible découvert
PILONAS COMPATIBLES / COMPATIBLE BOLLARDS / POTELETS COMPATIBLES:

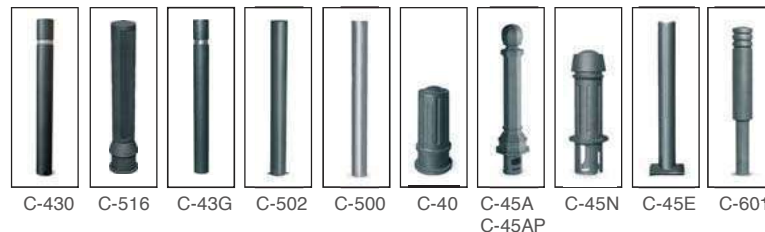

◀ BASE VARIO-501

Base desmontable con tapa / Removable base with cover / Base amovible avec couvert
PILONAS COMPATIBLES / COMPATIBLE BOLLARDS / POTELETS COMPATIBLES:



APARCABICIS

BICYCLE PARKING / SUPPORTS DE CYCLES

ONA

Mod. A-03

- Plancha galvanizada
- Galvanised steel
- Plaque en acier galvanisé

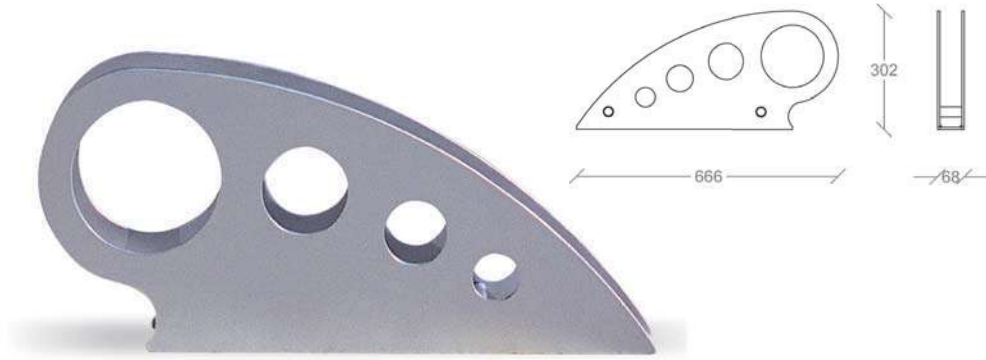

COPENHAGUEN

Mod. A-04

- Varillas de acero macizas. Galvanizado
- Solid steel bar. Galvanized
- Solid structure. Acier galvanisé

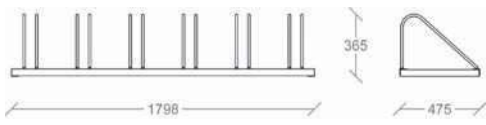

HOLANDA

Mod. A-1

- Acero galvanizado
- Galvanised steel
- Acier galvanisé

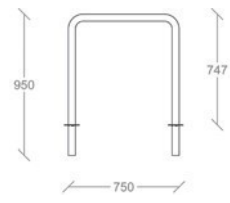
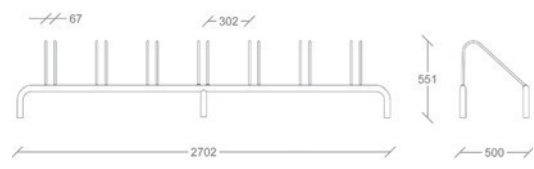
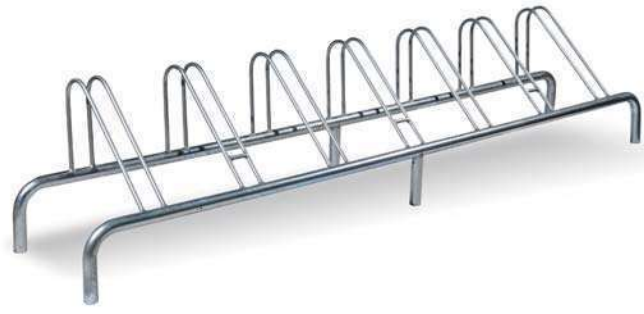

BARCELONA

Mod. A-06 / Mod. A-06 INOX

- Acero galvanizado / acero inoxidable aisi 304
- Galvanised steel / aisi 304 stainless steel
- Acier galvanisé / acier inox aisi 304

VARIOS / VARIOUS / DIVERS

SEPARADOR CARRIL BICI

CYCLE LANE SEPARATOR / SÉPARATEUR DE VOIES CYCLABLES

MODELO SKATE-G-BCN

Separador carril bici con reflectante superior fijo pintado.
820 x 200 x 127 mm

Cycle Lane Separator with superior reflective painted, fixed.
820 x 200 x 127 mm

Séparateur de voies cyclables, avec réflecteur supérieur fixe peint.
820 x 200 x 127 mm



OPCIONAL / OPTIONAL

MODELO SKATE-G





VARIOS / VARIOUS / DIVERS

SEPARADOR CARRIL BICI

CYCLE LANE SEPARATOR / SÉPARATEUR DE VOIES CYCLABLES

MODELO SKATE-G-16

Separador carril bici con reflectante superior desmontable pintado
820 x 200 x 127 mm

Cycle Lane Separator with superior reflective painted, removable
820 x 200 x 127 mm

Séparateur de voies cyclables, avec réflecteur supérieur amovible
peint
820 x 200 x 127 mm

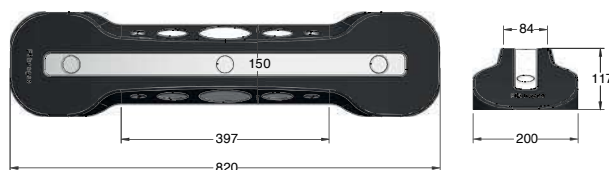

CENICEROS

ASHTRAYS / CENDRIERS



**ACCESORIOS
ACCESSORIES / ACCESSOIRES**

INOX

Mod. CE-2

Mod. CE-4

Cenicero de acero inoxidable para colgar
Adaptable a todo nuestro mobiliario urbano

Stainless steel ashtray
Adaptable to all our furniture

Cendrier en acier inoxydable
Adapté à tous notre mobilier

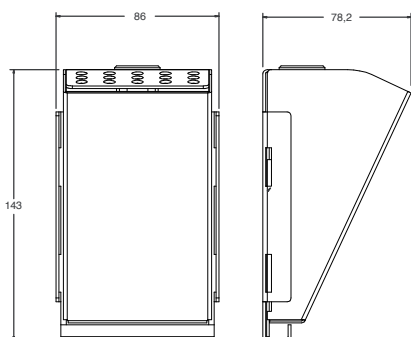

▲
Mod. CE-2



▲
Mod. CE-4

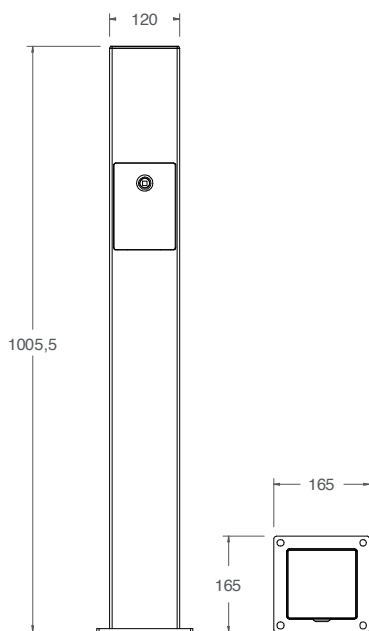
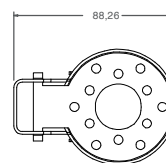
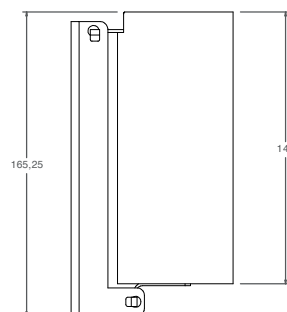

CENICERO DE PIE

Mod. CE-3

Cenicero de acero pintado en gris martelé

Steel ashtray black hammer paint

Cendrier en acier peint noir martelé

FAROLAS

STREET LIGHTING / ÉCLAIRAGE PUBLIC

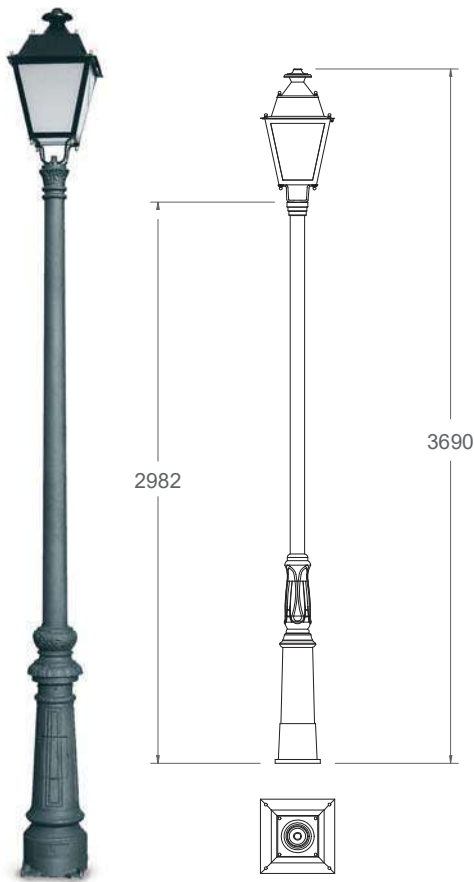

RONDA

Mod. FA-1

Fundición. Acabado oxirón negro
Material eléctrico y cableado no incluido

Cast iron. Powder coated with Oxiron paint
Electrical equipment and wiring not included

Fonte. Peint noir oxyron
Les équipements électriques et le câblage non inclus

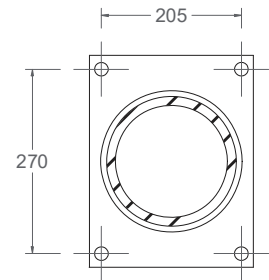

KIT MONTAJE FAROLA

Mod. FA-1-KIT

Plantilla de acero, 4 pernos, 8 tuercas y 8 arandelas

Steel template, 4 bolts, 8 nuts and 8 washers

Gabarit en acier, 4 vis, 8 écrous et 8 rondelles

DISPENSADORES

DISPENSERS / DISTRIBUTEUR



▲
Mod. T-1

▲
Mod. T-1-FE

TOTEM

Mod. T-1

Mod. T-1-FE

Mod T-1B (rollo 500 bolsas)

Dispensador de bolsas para pipi-can
Acero Inox 304 - Gris martelé

Dispenser of bags for Pipi can
Stainless steel 304 - Black hammer paint

Distributeur de sacs pour les déjection canines
Acier Inoxydable 304 - Noir martele

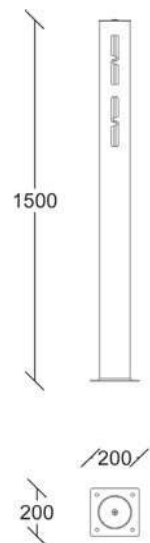

BALIZAS
BEACONS / BALISE

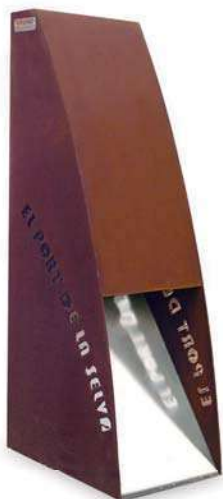

ESCOTA

Mod. BA-1

Estructura de acero corten
Luminaria de 125kw. Personalizable

Weathering Steel structure
125kw luminaire. Customizable

Estructure corten vernis
Luminaire 125kw. Personnalisable

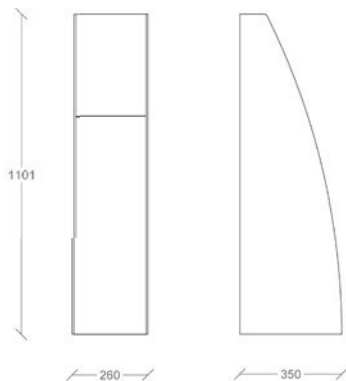

LA SEU

Mod. BA-2

Acero pintado + Inox
Lampara de bajo consumo, 12w (220v)

Steel coated with oxiron paint +
Stainless Steel
Energy saving lamp, 12w (220v)

Acier pient noir + Inox
Lampe à économie d'énergie, 12w (220v)

DECELERADOR
DECELERATORS / RALENTISSEURS



DECELERADOR RE-1

Mod. RE-1 50x40x5 cm

Mod. RE-1-FM 25x40x5 cm

Mod. RE-1-FH 25x40x5 cm

Caucho reciclado con bandas reflectantes

Recycled rubber with reflective inserts

Caoutchouc recyclé avec réfléchissant

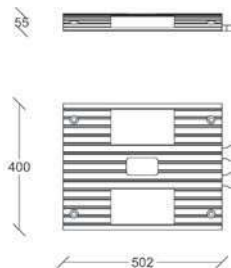

DECELERADOR RE-2

Mod. RE-2 47x60x3 cm

Mod. RE-2-FM 23x60x3 cm

Mod. RE-2-FH 23x60x3 cm

Caucho reciclado con bandas reflectantes

Recycled rubber with reflective inserts

Caoutchouc recyclé avec réfléchissant

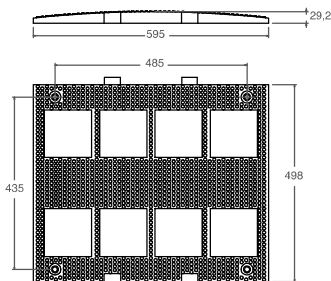
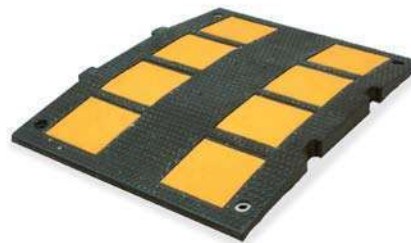

DUCHAS

SHOWERS / DOUCHES

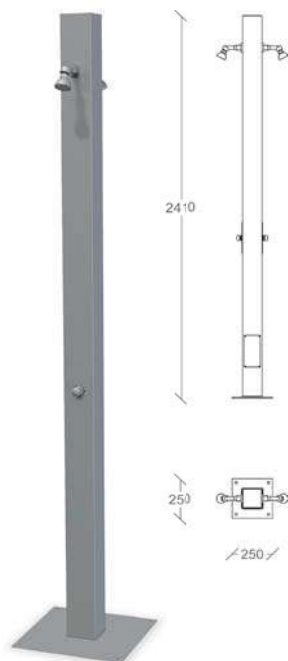

SAO PAULO

Mod. DU-6

Estructura acero inox aisi 316. 2 Rociadores orientables. Pulsadores temporizados

Aisi 316 stainless steel structure
Pushbuttons timed

Aisi 316 structure en acier inoxydable. 2 Jets orientables. Poussoirs temporisée

FUENTE LAVAPIES

Mod. LA-1

Lavapies y fuente en acero inoxidable
Pulsadores temporizados

Foot shower and fountain made of stainless steel. Pushbuttons timed

Fontaine inox. Poussoirs temporisée



VALLAS

FENCES / BARRIÈRES



PARIS

Mod. VALLA-2-240

Acero pintado oxiron

Steel oxiron painted

Acier peint oxiron



RÚSTICA

Mod. V-05

Madera de pino tratado en autoclave
Tramos de 2000x1000 mm

Autoclave pine wood. Sections 2000x1000 mm

Bois de pin autoclave. 2000X1000 mm



FUSTA

Mod. E-VALLA-T

Madera de pino tratado en autoclave
Tramos de 2000x1000 mm
Se incluyen postes de cogida

Autoclave pine wood
Sections 2000x1000 mm. Posts included

Bois de pin autoclave. 2000X10000 mm



VALLAPLAS

Mod. P-500

Polietileno 100%

Polyethylene 100%

100% Polyéthylène

BIOSALUDABLES PARA ADULTOS**OUTDOOR GYMS FOR ADULTS / FITNESS POUR LES ADULTES****ESQUI DE FONDO****Mod. WD-010425**

Desarrolla la fuerza y coordinación de brazos, piernas y cintura. Fortalece las funciones cardíacas y pulmonares.

Develops strength and coordination of arms, legs and waist. Strengthens heart and lung functions.

Développe la force et de la coordination des bras, jambes et la taille. Renforce les fonctions cardiaques et pulmonaires.

**LA VELA****Mod. WD-010415**

Refuerzo de la función cardíaca y pulmonar, y coordinación general del cuerpo, mejorando la circulación y el sistema digestivo. Ejercita la columna vertebral y la cadera.

Strengthening the cardiac and lung function, and coordination general body, improving circulation and the digestive system. Exercise the spine and hip.

Renforce les fonction cardiaques et pulmonaires et la coordination globale du corps, l'amélioration de la circulation et le système digestif. Pour exercer la colonne vertébrale et la hanche.

**ELEVADOR****Mod. WD-010471**

Ejercicio que fortalece y desarrolla el tren inferior. También es un aparato de ayuda en la rehabilitación de lesiones, ya que con los brazos se controla la intensidad del ejercicio.

Exercise that strengthens and expands the bottom. It also is an aid in the rehabilitation of injuries, as with arms control the exercise intensity.

Exercice que renforce et développe la partie inférieure du corps. Il est également un dispositif d'assistance à la réhabilitation des blessures, car avec le bras est commandée l'intensité de l'exercice.



BIOSALUDABLES PARA ADULTOS
OUTDOOR GYMS FOR ADULTS / FITNESS POUR LES ADULTES

BANCO DE ABDOMINALES

Mod. WD-010423

Mejora de la musculatura abdominal y lumbar, el consumo de grasa abdominal genera una mejor figura.

Improvement of the lumbar and abdominal muscles, the abdominal fat consumption produces a better picture.

L'Amélioration des muscles abdominaux et les lombaires. La consommation en graisses abdominales conduit à une meilleure figure.



EL CÍRCULO

Mod. WD-010488

Desarrollo de la potencia muscular de hombros, mejorando la agilidad y flexibilidad de las articulaciones de hombro, codo, muñecas y fortaleciendo las funciones cardiacas y pulmonar.

Development of the shoulder muscle strength, improve agility and flexibility of joints of shoulder, elbow, wrist, and strengthen the heart and lung functions.

Développement de la puissance musculaire de l'épaule. L'amélioration de l'agilité et la souplesse des articulations de l'épaule, du coude, du poignet, et de renforcer les fonctions cardiaques et pulmonaires.



MASAJE DE ESPALDA

Mod. WD-010414

Relajación de la musculatura de cadera y espalda, mejorando la fatiga corporal y el sistema nervioso.

Relaxation of the hip and back muscles, improving physical fatigue and nervous system.

Détente des muscles de la hanche et le dos, l'amélioration de la fatigue du corps et le système nerveux.



BIOSALUDABLES PARA ADULTOS

OUTDOOR GYMS FOR ADULTS / FITNESS POUR LES ADULTES

EL VOLANTE

Mod. WD-010402

Refuerzo de la musculatura abdominal y lumbar, mejorando la flexibilidad y agilidad de la columna vertebral y articulación de cadera. Bueno para mejorar la cintura.

Strengthening the abdominal and lumbar muscles, improving flexibility and agility of the spine and hip joint. Good for improving the waist.

Renforcer les muscles abdominaux et lombaires, d'améliorer la flexibilité et l'agilité de la colonne vertébrale et la hanche. Bon pour l'amélioration de la taille.



BARRAS PARALELAS

Mod. WD-010473

Fuerza y flexibilidad de los miembros superiores, hombros y pectorales, mejora de abdomen y espalda.

Strength and flexibility of the upper limbs, shoulders and chest, abdomen and back improved.

Force et flexibilité des membres supérieurs, les épaules et les pectoraux, l'amélioration de l'abdomen et le dos.



EL CABALLO

Mod. WD-010492

Fortalecimiento de las funciones cardíaca y pulmonar, desarrollo de la musculatura de brazos y piernas, cintura, abdomen y espalda, mejorando la coordinación entre los cuatro.

Strengthening the cardiac and lung functions, development of muscles of arms and legs, waist, abdomen and back, improving coordination among the four.

Renforcer le développement cardiaque et la fonction pulmonaire, développement de la musculature des bras et des jambes, la taille, abdomen et le dos, l'amélioration de la coordination entre les quatre.



BIOSALUDABLES PARA ADULTOS
OUTDOOR GYMS FOR ADULTS / FITNESS POUR LES ADULTES

REMO

Mod. WD-010417

Fortalece principalmente la musculatura dorsal, así como hombros y bíceps. Ideal para el calentamiento de articulaciones antes de un entrenamiento con cargas.

Primarily strengthens the dorsal musculature, as well as shoulders and biceps. Ideal for warming up before a joint training loads.

Renforce principalement les muscles du dos et des épaules et des biceps. Idéal pour l'échauffement avant un entraînement avec charges.



PASEO DOBLE

Mod. WD-010489

Fortalece las funciones cardíaca y pulmonar, desarrollando la flexibilidad y coordinación de los miembros inferiores.

Strengthens the cardiac and lung functions, developing flexibility and coordination of the lower limbs.

Renforce les fonctions cardiaques et pulmonaires, le développement la flexibilité et la coordination des les membres inférieures.



PASEO SIMPLE

Mod. WD-010409

Fortalece las funciones cardíaca y pulmonar, desarrollando la flexibilidad y coordinación de los miembros inferiores.

Strengthens cardiac and lung functions, developing flexibility and coordination of the lower limbs.

Renforce les fonctions cardiaques et pulmonaires, le développement la flexibilité et la coordination des les membres inférieures.



BIOSALUDABLES PARA ADULTOS**OUTDOOR GYMS FOR ADULTS / FITNESS POUR LES ADULTES****ESTIRAMIENTO DE PIERNAS****Mod. WD-010404**

Fortalece las funciones cardíaca y pulmonar, desarrollando la flexibilidad y coordinación de los miembros inferiores.

Strengthens the cardiac and lung functions, developing flexibility and coordination of the lower limbs.

Renforce les fonctions cardiaques et pulmonaires, le développement la souplesse et la coordination des membres inférieures.

**LA BICICLETA****Mod. WD-010491**

Fortalece las funciones cardíaca y pulmonar, desarrollando la flexibilidad y coordinación de los miembros inferiores.

Strengthens the cardiac and lung functions, developing flexibility and coordination of the lower limbs.

Renforce les fonctions cardiaques et pulmonaires, le développement la souplesse et la coordination des membres inférieures.

**LAS RUEDAS****Mod. WD-010487**

Desarrollo de la potencia muscular de hombros, mejorando la agilidad y flexibilidad de las articulaciones de hombro, codo, muñecas y fortaleciendo las funciones cardíacas y pulmonar.

Development of the shoulder muscle strength, improve agility and flexibility of joints of shoulder, elbow, wrist, and strengthen the heart and lung functions.

Développement de la puissance musculaire de l'épaule. L'amélioration de l'agilité et la souplesse des articulations de l'épaule, du coude, du poignet, et de renforcer les fonctions cardiaques et pulmonaires.



Fàbregas

www.grupfabregas.com

grupfabregas@grupfabregas.com



Fábregas

Parques y Jardines Fábregas S.A.U.

PARQUES Y JARDINES FÁBREGAS

Gran Bretanya, 41 (Pol. Ind. Les Comes)

08700 Igualada · BARCELONA (SPAIN)

Tel. +34 93 805 11 25

Fax +34 93 803 27 31



Fábregas

Fundición Dúctil Fábregas S.A.U.

FUNDICIÓN DÚCTIL FÁBREGAS

Gran Bretanya, 41 (Pol. Ind. Les Comes)

08700 Igualada · BARCELONA (SPAIN)

Tel. +34 93 805 11 25

Fax +34 93 803 27 31



Fábregas Urban S.A.U.

FÁBREGAS URBAN

Montduber, 3

46960 Aldaia · VALENCIA (SPAIN)

Tel. +34 96 151 53 44

Fax +34 96 151 75 65



Urbancity Ibérica S.L.U.

URBANCITY IBÉRICA

Montduber, 3

46960 Aldaia · VALENCIA (SPAIN)

Tel. +34 96 151 53 44

Fax +34 96 151 75 65



www.grupfabregas.com

grupfabregas@grupfabregas.com